

GT-10

GUITAR EFFECTS PROCESSOR

Owner's Manual

Thank you, and congratulations on your choice of the BOSS GT-10.

Before using this unit, carefully read the sections entitled: "USING THE UNIT SAFELY" (p. 2-3), and "IMPORTANT NOTES" (p. 4-5). These sections provide important information concerning the proper operation of the unit. Additionally, in order to feel assured that you have gained a good grasp of every feature provided by your new unit, Owner's manual should be read in its entirety. The manual should be saved and kept on hand as a convenient reference.





Copyright © 2008 BOSS CORPORATION

All rights reserved. No part of this publication may be reproduced in any form without the written permission of BOSS CORPORATION.







USING THE UNIT SAFELY

INSTRUCTIONS FOR THE PREVENTION OF FIRE, ELECTRIC SHOCK, OR INJURY TO PERSONS

About WARNING and CAUTION Notices







 WARNING	Used for instructions intended to alert the user to the risk of death or severe injury should the unit be used improperly.
 CAUTION	Used for instructions intended to alert the user to the risk of injury or material damage should the unit be used improperly. * Material damage refers to damage or other adverse effects caused with respect to the home and all its furnishings, as well to domestic animals or pets.

About the Symbols





	The  symbol alerts the user to important instructions or warnings. The specific meaning of the symbol is determined by the design contained within the triangle. In the case of the symbol at left, it is used for general cautions, warnings, or alerts to danger.
	The  symbol alerts the user to items that must never be carried out (are forbidden). The specific thing that must not be done is indicated by the design contained within the circle. In the case of the symbol at left, it means that the unit must never be disassembled.
	The  symbol alerts the user to things that must be carried out. The specific thing that must be done is indicated by the design contained within the circle. In the case of the symbol at left, it means that the power-cord plug must be unplugged from the outlet.

ALWAYS OBSERVE THE FOLLOWING

WARNING

- Do not open (or modify in any way) the unit or its AC adaptor. 
- Do not attempt to repair the unit, or replace parts within it (except when this manual provides specific instructions directing you to do so). Refer all servicing to your retailer, the nearest Roland Service Center, or an authorized Roland distributor, as listed on the "Information" sheet. 
- Never use or store the unit in places that are:
 - Subject to temperature extremes (e.g., direct sunlight in an enclosed vehicle, near a heating duct, on top of heat-generating equipment); or are 
 - Damp (e.g., baths, washrooms, on wet floors); or are 
 - Humid; or are
 - Exposed to rain; or are
 - Dusty; or are
 - Subject to high levels of vibration.
- Make sure you always have the unit placed so it is level and sure to remain stable. Never place it on stands that could wobble, or on inclined surfaces. 
- Be sure to use only the AC adaptor supplied with the unit. Also, make sure the line voltage at the installation matches the input voltage specified on the AC adaptor's body. Other AC adaptors may use a different polarity, or be designed for a different voltage, so their use could result in damage, malfunction, or electric shock. 

WARNING

- Use only the attached power-supply cord. Also, the supplied power cord must not be used with any other device. 
- Do not excessively twist or bend the power cord, nor place heavy objects on it. Doing so can damage the cord, producing severed elements and short circuits. Damaged cords are fire and shock hazards! 
- This unit, either alone or in combination with an amplifier and headphones or speakers, may be capable of producing sound levels that could cause permanent hearing loss. Do not operate for a long period of time at a high volume level, or at a level that is uncomfortable. If you experience any hearing loss or ringing in the ears, you should immediately stop using the unit, and consult an audiologist. 
- Do not allow any objects (e.g., flammable material, coins, pins); or liquids of any kind (water, soft drinks, etc.) to penetrate the unit. 

⚠ WARNING

- Immediately turn the power off, remove the AC adaptor from the outlet, and request servicing by your retailer, the nearest Roland Service Center, or an authorized Roland distributor, as listed on the “Information” page when:
 - The AC adaptor, the power-supply cord, or the plug has been damaged; or
 - If smoke or unusual odor occurs
 - Objects have fallen into, or liquid has been spilled onto the unit; or
 - The unit has been exposed to rain (or otherwise has become wet); or
 - The unit does not appear to operate normally or exhibits a marked change in performance.



- In households with small children, an adult should provide supervision until the child is capable of following all the rules essential for the safe operation of the unit.



- Protect the unit from strong impact. (Do not drop it!)



- Do not force the unit’s power-supply cord to share an outlet with an unreasonable number of other devices. Be especially careful when using extension cords—the total power used by all devices you have connected to the extension cord’s outlet must never exceed the power rating (watts/amperes) for the extension cord. Excessive loads can cause the insulation on the cord to heat up and eventually melt through.



- Before using the unit in a foreign country, consult with your retailer, the nearest Roland Service Center, or an authorized Roland distributor, as listed on the “Information” sheet.



⚠ CAUTION

- The unit and the AC adaptor should be located so their location or position does not interfere with their proper ventilation.



- Always grasp only the plug on the AC adaptor cord when plugging into, or unplugging from, an outlet or this unit.



- At regular intervals, you should unplug the AC adaptor and clean it by using a dry cloth to wipe all dust and other accumulations away from its prongs. Also, disconnect the power plug from the power outlet whenever the unit is to remain unused for an extended period of time. Any accumulation of dust between the power plug and the power outlet can result in poor insulation and lead to fire.



- Try to prevent cords and cables from becoming entangled. Also, all cords and cables should be placed so they are out of the reach of children.



- Never climb on top of, nor place heavy objects on the unit.



- Never handle the AC adaptor or its plugs with wet hands when plugging into, or unplugging from, an outlet or this unit.



- Before moving the unit, disconnect the AC adaptor and all cords coming from external devices.



- Before cleaning the unit, turn off the power and unplug the AC adaptor from the outlet (p.26).



- Whenever you suspect the possibility of lightning in your area, disconnect the AC adaptor from the outlet.



- Should you remove the screw and the USB connector cap, keep them in a safe place out of children’s reach, so there is no chance of them being swallowed accidentally.



IMPORTANT NOTES

Power Supply

- Do not connect this unit to same electrical outlet that is being used by an electrical appliance that is controlled by an inverter (such as a refrigerator, washing machine, microwave oven, or air conditioner), or that contains a motor. Depending on the way in which the electrical appliance is used, power supply noise may cause this unit to malfunction or may produce audible noise. If it is not practical to use a separate electrical outlet, connect a power supply noise filter between this unit and the electrical outlet.
- The AC adaptor will begin to generate heat after long hours of consecutive use. This is normal, and is not a cause for concern.
- Before connecting this unit to other devices, turn off the power to all units. This will help prevent malfunctions and/or damage to speakers or other devices.

Placement

- Using the unit near power amplifiers (or other equipment containing large power transformers) may induce hum. To alleviate the problem, change the orientation of this unit; or move it farther away from the source of interference.
- This device may interfere with radio and television reception. Do not use this device in the vicinity of such receivers.
- Noise may be produced if wireless communications devices, such as cell phones, are operated in the vicinity of this unit. Such noise could occur when receiving or initiating a call, or while conversing. Should you experience such problems, you should relocate such wireless devices so they are at a greater distance from this unit, or switch them off.
- When moved from one location to another where the temperature and/or humidity is very different, water droplets (condensation) may form inside the unit. Damage or malfunction may result if you attempt to use the unit in this condition. Therefore, before using the unit, you must allow it to stand for several hours, until the condensation has completely evaporated.
- Depending on the material and temperature of the surface on which you place the unit, its rubber feet may discolor or mar the surface. You can place a piece of felt or cloth under the rubber feet to prevent this from happening. If you do so, please make sure that the unit will not slip or move accidentally.

Maintenance

- For everyday cleaning wipe the unit with a soft, dry cloth or one that has been slightly dampened with water. To remove stubborn dirt, use a cloth impregnated with a mild, non-abrasive detergent. Afterwards, be sure to wipe the unit thoroughly with a soft, dry cloth.
- Never use benzine, thinners, alcohol or solvents of any kind, to avoid the possibility of discoloration and/or deformation.

Repairs and Data

- Please be aware that all data contained in the unit's memory may be lost when the unit is sent for repairs. Important data should always be backed up on another MIDI device (e.g., a sequencer), or written down on paper (when possible). During repairs, due care is taken to avoid the loss of data. However, in certain cases (such as when circuitry related to memory itself is out of order), we regret that it may not be possible to restore the data, and Roland assumes no liability concerning such loss of data.

Additional Precautions

- Please be aware that the contents of memory can be irretrievably lost as a result of a malfunction, or the improper operation of the unit. To protect yourself against the risk of losing important data, we recommend that you periodically save a backup copy of important data you have stored in the unit's memory in another MIDI device (e.g., a sequencer).
- Unfortunately, it may be impossible to restore the contents of data that was stored in another MIDI device (e.g., a sequencer) once it has been lost. Roland Corporation assumes no liability concerning such loss of data.
- Use a reasonable amount of care when using the unit's buttons, sliders, or other controls; and when using its jacks and connectors. Rough handling can lead to malfunctions.
- Never strike or apply strong pressure to the display.
- When connecting / disconnecting all cables, grasp the connector itself—never pull on the cable. This way you will avoid causing shorts, or damage to the cable's internal elements.
- To avoid disturbing your neighbors, try to keep the unit's volume at reasonable levels. You may prefer to use headphones, so you do not need to be concerned about those around you (especially when it is late at night).
- When you need to transport the unit, package it in the box (including padding) that it came in, if possible. Otherwise, you will need to use equivalent packaging materials.

- Use only the specified expression pedal (Roland EV-5, BOSS FV-500L/500H with a connection cable (stereo 1/4" phone – stereo 1/4" phone); sold separately). By connecting any other expression pedals, you risk causing malfunction and/or damage to the unit.
- Some connection cables contain resistors. Do not use cables that incorporate resistors for connecting to this unit. The use of such cables can cause the sound level to be extremely low, or impossible to hear. For information on cable specifications, contact the manufacturer of the cable.

Copyright

- This product can be used to record or duplicate audio without being limited by certain technological copy-protection measures. This is due to the fact that this product is intended to be used for the purpose of producing original music, and is therefore designed so that material that does not infringe copyrights belonging to others (for example, your own original works) can be recorded or duplicated freely.
- Do not use this unit for purposes that could infringe on a copyright held by a third party. We assume no responsibility whatsoever with regard to any infringements of third-party copyrights arising through your use of this unit.

Printing Conventions and icons in This Manual

Text or numerals enclosed in square brackets []	Indicate buttons. [WRITE] WRITE button
NOTE	Indicates information that you should be aware of when using the GT-10.
MEMO	Indicates supplementary information about an operation.
TIP	Indicates information about a convenient operation.
cf. → (p.**)	Indicates a reference page.

About the Explanations of Procedures in the Text

- For selecting items like those shown in the screen view below, the explanations describe how to make the selection using the knobs, but you can also select the items using [◀] and [▶] (the cursor buttons).

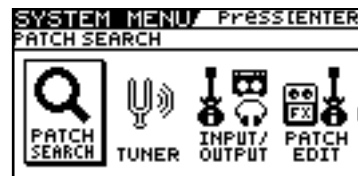

Contents

IMPORTANT NOTES	4
Main Features	10
Names of Things and What They Do.....	11
Front Panel.....	11
Rear Panel	13
Quick Guide	14
Getting Ready	14
Playing Sounds	16
Editing	18
Basic Operation.....	18
Creating Sounds Based on Existing Patches	18
Creating Sounds with Ease	20
Chapter 1 Playing Sounds	22
Making the Connections.....	22
Turning on the Power	23
The Icons in the Play Screen	23
Switching the Play Screen	24
Adjusting the Output Level	24
Making Settings for a Connected Device (Output Select)	25
Turning Off the Power.....	26
Tuning the Guitar (TUNER)	26
Turning the Tuner Function On and Off	26
About the Display During Tuning	26
How to Tune	27
Changing the Tuner Settings (Tuner Pitch).....	27
Changing the Tuner Settings (Tuner Out).....	28
Selecting a Tone (Patch Change)	29
What is a Patch?.....	29
Using the Pedal to Select the Patch.....	30
Using the Dial to Select the Patch	31
Separating Patches into Groups (CATEGORY).....	31
Adjusting a Tone	31
Chapter 2 Creating Sounds (Patch Edit).....	32
Creating Sounds with Ease (EZ TONE)	32
Creating a Tone for the Song You Envision (Create).....	32
Adjusting the Tone (Edit).....	33
Setting the Effects	34
Turning an Effect On and Off.....	34
Setting the Effects Simply (Quick Setting).....	35
Switching Between Knob View and List View	35
Adjusting the Parameters.....	36
Changing the Connection Order of Effects (Effect Chain)	38
Grouping Patches by Category (CATEGORY)	39
Naming User Categories (CATEGORY NAME)	40
Naming a Patch (PATCH NAME)	41

Chapter 3 Saving a Tone	42
Saving a Patch (PATCH WRITE)	42
Copying Patches (PATCH COPY)	42
Exchanging Patches (PATCH EXCHANGE).....	43
Initializing Patches (PATCH INITIALIZE).....	43
Storing Settings by Effect (User Quick Settings).....	44
Copying or Swapping PREAMP Settings Between Channels	45
Chapter 4 Playing Sounds	46
Setting the Functions of the Knobs of the Play Screen	46
Using Pedals to Control the Parameters	47
Using the CTL/EXP Pedal With the Same Functions Assigned at All Times (Pedal Function)	47
Setting CTL/EXP Functions Individually in Each Patch (Pedal FX).....	48
Setting Each Controller Functions to Individual Patches (Assign).....	50
Activating the Virtual Expression Pedal at the Start of Operations (Internal Pedal System)....	54
Turning the Effects On and Off with the BANK/Number Pedals (Manual Mode).....	55
Switching to Manual Mode	55
Switching Effects On and Off with the Pedals.....	55
Assigning an Effect On/Off Switch to a Pedal	56
Switching Settings with the Number Pedals.....	57
Phrase Loop Play	58
What's Phrase Loop?	58
Using the Phrase Loop	58
Setting Phrase Loop	59
Overview of Phrase Loop Operation	60
Chapter 5 Making Global Settings.....	61
Making Settings Matched to the Connected Guitar (Input Select)	61
Adjusting the Overall Sound to Match the Usage Environment (Global)	62
Adjusting the Overall Tone (Global EQ)	62
Controlling the Overall Effect of the Noise Suppressor (Total Noise Suppressor)	63
Controlling the Overall Reverb Level (Total REVERB).....	64
Setting the Output Reference Level to Match the Connected Equipment (Main Out Level)	65
Adjusting the Output Level of the DIGITAL OUT Jack.....	66
Adjusting the Display Contrast (LCD Contrast).....	67
Keeping Effect Sounds Playing After Patches Are Switched (Patch Change Mode)	68
Using the Identical Preamp Settings in All Patches (Preamp Mode)	69
Using the System Preamp	69
Setting the System Preamp	69
Saving the Current Preamp Setting As the System's Preamp Setting	70
Limiting the Banks That Can Be Switched (Bank Extent)	71
Setting the Timing Used for Switching Patches (Bank Change Mode)	72
Having Values from an EXP Pedal Carried Over When Patches are Called Up (EXP Pedal Hold)....	73
Switching How the Pedal Indicators Light (Pedal Indicate).....	74
Selecting the Dial Function (Dial Function).....	75
Restoring the Factory Settings (Factory Reset).....	76
Adjusting the EXP Pedal	77
Chapter 6 Using the GT-10 with External MIDI Devices Connected...79	
What Can You Do with MIDI?	79
Operating From the GT-10.....	79
Remotely Controlling the GT-10 Using an External MIDI Device.....	79
Making the Settings for MIDI Functions.....	80
Setting the MIDI Receive Channel.....	80
Setting the MIDI Omni Mode.....	81
Setting the MIDI Transmit Channel	81
Setting the MIDI Device ID.....	81
Setting the MIDI Sync Clock.....	81
Sending Program Change Messages	82
Sending EXP Pedal Operations as Control Change Messages	82
Sending EXP Pedal Sw Operations as Control Change Messages.....	82

Sending External EXP Pedal Operations as Control Change Messages	82
Sending CTL Pedal Operations as Control Change Messages	83
Sending External Footswitch Operations as Control Change Messages	83
Setting the Correspondences Between Program Change Messages and Patches (Program Change Map)	84
Enabling/Disabling the Program Change Map Settings (MIDI Map Select)	84
Setting the Program Change Map	84
Changing Patches Using Bank Select Messages	85
Changing Patch Numbers on an External MIDI Device from the GT-10	85
Changing Patch Numbers on the GT-10 from an External MIDI Device	86
Transmitting Data to an External MIDI Device (Bulk Dump)	87
Making the Connections	87
Transmitting	88
Receiving Data from an External MIDI Device (Bulk Load)	89
Making the Connections	89
Receiving	89

Chapter 7 Using the GT-10 Connected to a Computer Via USB90

Before Connecting with USB	90
Installing and Setting the USB Driver	90
Switching the Driver Mode	91
Setting the USB Functions	92
Setting the Digital Audio Signal Input and Output	92
Setting the Direct Monitor	93
Controlling the Direct Monitor Setting from an External Device	94
Recording the GT-10's Output with a Computer	94
Applying GT-10 Effects to a Computer's Audio Playback	95

Chapter 8 Parameters Guide.....96

COMP (Compressor)	96
OD/DS (Overdrive/Distortion)	96
PREAMP	98
Preamp Type List	98
EQ (Equalizer)	101
FX-1/FX-2	102
T.WAH (Touch Wah)	102
AUTO WAH (Auto Wah)	103
SUB WAH	103
ADV.COMP(Advanced Compressor)	104
LIMITER	104
GRAPHIC EQ (Graphic Equalizer)	104
PARA EQ (Parametric Equalizer)	105
TONE MODIFY	105
GUITAR SIM. (Guitar Simulator)	106
SLOW GEAR	106
DEFRETTER	106
WAVE SYNTH	107
GUITAR SYNTH	107
SITAR SIM. (Sitar Simulator)	108
OCTAVE	109
PITCH SHIFTER	109
HARMONIST	110
AUTO RIFF	111
Creating Original Phrases (User Phrase)	112
SOUND HOLD	112
AC.PROCESSOR (Acoustic Processor)	112
FEEDBACKER	113
ANTI-FEEDBACK	113
PHASER	114
FLANGER	114
TREMOLO	115
ROTARY	115
UNI-V	115

PAN.....	115
SLICER.....	116
VIBRATO.....	116
RING MOD. (Ring Modulator)	117
HUMANIZER.....	117
2X2 CHORUS.....	118
SUB DELAY	118
DELAY	119
DELAY Common Parameters	119
Pan.....	120
Dual-S, Dual-P, Dual-L/R.....	120
Warp.....	120
Modulate	120
CHORUS.....	121
REVERB	121
MASTER	122
MASTER BPM/KEY	122
PEDAL FX.....	122
SW&PDL FUNCTION.....	122
ASSIGN 1–8.....	126
TARGET PARAMETER	127
SEND/RETURN.....	132
AMP CONTROL.....	132
NS1/NS2 (Noise Suppressor).....	133
EZ TONE	133
STEP1: SETTING.....	133
STEP2: TONE.....	134
STEP3: DRIVE.....	134
STEP4: EFX.....	134
SYSTEM	134
TUNER.....	134
INPUT/OUTPUT	134
PHRASE LOOP	135
MANUAL MODE SETTING	136
PLAY OPTION	136
CONTROLLER.....	137
LCD	139
MIDI.....	139
USB.....	140
OUTPUT SELECT.....	141
Appendices.....	142
Signal Flow	142
MIDI Implementation Chart.....	143
Specifications.....	144
Error Messages.....	145
Troubleshooting.....	145
Problems with the sound	145
Other Problems.....	146
Index.....	147

Main Features

Newer, More Powerful BOSS COSM Effects

Totally new effects made possible by an original, high-performance processor that relies on the latest BOSS technology.

Utilizing COSM technology that transcends the realm of mere modeling, these effects achieve sounds with an even more natural performance feel and richer expressiveness than previous designs.

Create Tones Intuitively with EZ TONE

The EZ TONE provides an innovative user interface that enables you to create your own tones with absolutely no special knowledge of effect parameters needed.

Sound making on the EZ TONE is truly intuitive. EZ TONE shows you the way to create the sound with both graphical icons and intuitive terms such as “SOFT” or “HARD.” Choose the basic sound you want according to the music genre, song imagery, performance-style. Then you can shape the sound by just moving the cursor on the TONE GRID toward “SOFT” or “HARD,” “for SOLO” or “for BACKING.”

Now everyone can easily create his or her own tones the instant a sonic image comes to mind.

Phrase Loop Feature

The Phrase Loop feature lets you record and play loop performances, whereby you continue adding new sounds as the loop plays.

Up to 38 seconds of recording time means you can switch effects as you add rhythm, solos, and other performance touches to a recorded loop.

You can also take phrases recorded beforehand without effects and then apply the perfect tone, adding the effects as you play back the phrase.

A Wide Variety of Tones with Parallel Chain

The GT-10 features a “Parallel Chain” function, which allows you to split the effects “chain”—the sequence of effects used in processing the sound—to create two independent chains. Each chain gives you full freedom to arrange effects in any order you want.

You can, for example, use separate chain settings in the left and right stereo channels to produce an effect just like a twin guitar sound. Additionally, using a dynamic-type COSM amp, you can even switch chains with your picking dynamics.

Works Like a Compact Effects Processor

Operating the GT-10 is like using compact effects processors. It's easy to make super-fast tone adjustments, even in the middle of live performances. Just select an effects type, then directly adjust the four optimal parameters with the front-panel knobs. Of course, you can also switch the display to show all effect parameters to create tones with even more exacting detail.

High-Visibility Indicators

Foot pedal indicators and other lights all utilize brightly lit LEDs. Clearly visible in any situation, whether it be in a live outdoor concert or up on a pitch-black stage, these indicators help ensure accurate operation.

Names of Things and What They Do

Front Panel

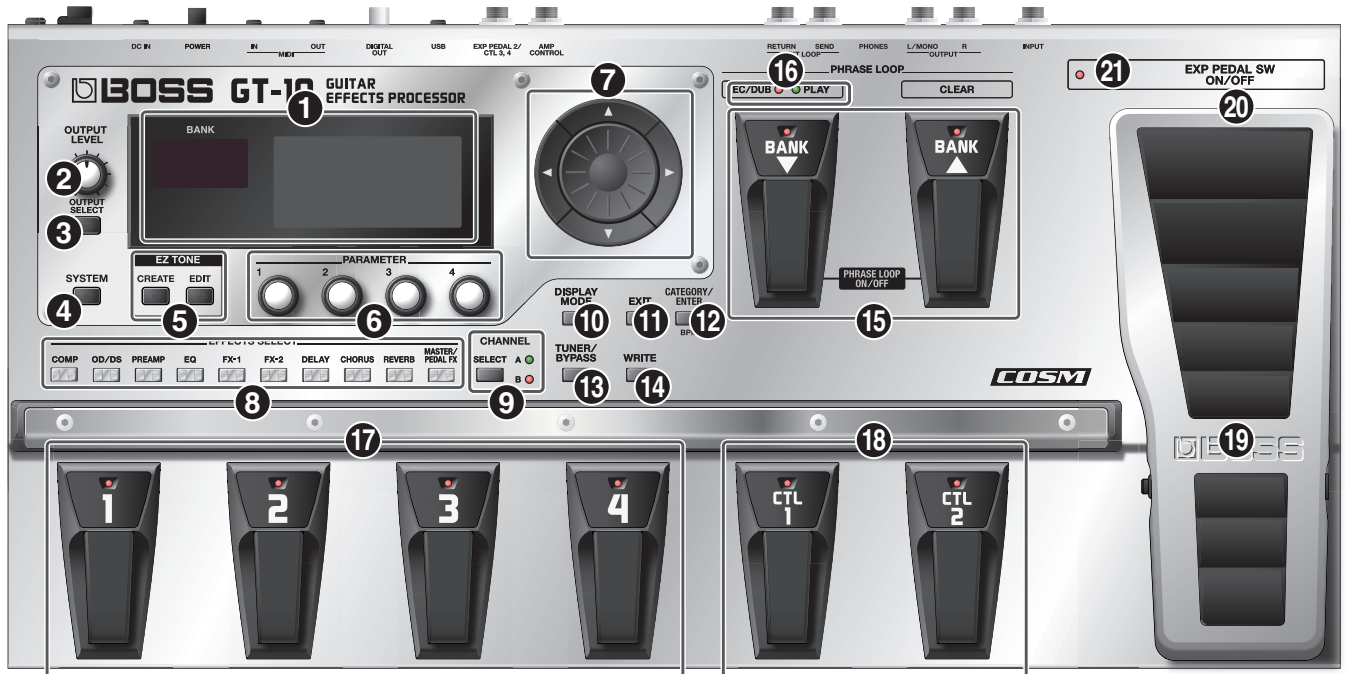

1. Display

Various information about the GT-10 is shown here. The display screen on the left side shows the bank number.

2. OUTPUT LEVEL Knob

This adjusts the volume level at the OUTPUT jack and the PHONES jack.

3. OUTPUT SELECT Button

This adjusts the characteristics of the output from the GT-10 to match the type of equipment that is connected (p. 24).

4. SYSTEM Button

This makes global settings for the GT-10 (p. 61).

5. EZ TONE

CREATE Button

This makes it easy to create tones based on the musical genre and the feel of the song you have in mind (p. 32).

EDIT Button

This provides a simple way to modify tones (p. 33).

6. Parameter Knobs P1 Through P4

These change the values of the parameter shown on the display.

7. Dial

This switches patches and modifies values.

[▲], [▼], [◀], and [▶] (Cursor Buttons)

These move the onscreen cursor up, down, or to the left or right.

8. EFFECTS SELECT

Use these buttons to switch effects on or off, or to change their settings (p. 34). When an effect is switched on, the button's indicator lights up; the indicator goes out when the effect is off.

* [MASTER/PEDAL FX] does not light up.

COMP (Compressor) Button

OD/DS (Overdrive/Distortion) Button

PREAMP Button

EQ (Equalizer) Button

FX-1 Button

FX-2 Button

DELAY Button

CHORUS Button

REVERB Button

MASTER/PEDAL FX (Master/Pedal Effect) Button

9. SELECT Button

These switch between the A and B channels for the PREAMP (p. 98).

10. DISPLAY MODE Button

Allows you to change the way things are shown in the display (p. 24).

11. EXIT Button

Use this to go back to the previous screen or to cancel an operation.

12. CATEGORY/ENTER Button

Use this button for the following operations:

- When executing an operation
- When selecting patches arranged by category (p. 31)
- When doing tap input for MASTER BPM (p. 122) or Delay Time (p. 119)

13. TUNER/BYPASS Button

Press to use the tuner features (p. 26).

14. WRITE Button

Use this to store patch settings in memory, or to replace or copy settings (p. 42).

15. BANK Pedals

Use these when switching patch banks (p. 30) or performing operations with phrase loops (p. 58).

MEMO

You can switch a phrase loop on or off by depressing the two BANK pedals at the same time (p. 58).

16. PHRASE LOOP (p. 58)

REC/DUB (Recording/Overdubbing) Indicator

This lights steadily when you're recording or overdubbing a phrase, and flashes during recording standby.

PLAY Indicator

This lights up while phrase playback is in progress.

17. Number Pedals 1 through 4

These switch the patch number (p. 30).

18. CTL (Control) Pedals 1 and 2

These can be used to control a variety of functions you assign, such as the A and B channels for the PREAMP (p. 98) or switching the Tuner on or off (p. 47).

19. EXP (Expression) Pedal

Controls volume, wah, and other parameters (p. 47).

NOTE

When operating the EXP Pedal, be careful not to get your fingers pinched between the movable part and the panel. In places with small children, an adult should provide supervision and guidance until the child is capable of following all the rules essential for the safe operation of the unit.

20. EXP PEDAL SW (EXP Pedal Switch)

The switch is turned on or off by firmly pressing on the toe of the EXP Pedal.

21. EXP PEDAL SW ON/OFF

(EXP Pedal Switch On/Off) Indicator

This lights up when the feature controlled by the EXP PEDAL SW is on and goes out when the controlled feature is off.

Rear Panel



1. INPUT Jack

The guitar is connected here.

2. OUTPUT L/MONO R Jacks

Connect to your amp, mixer, or such device.

3. PHONES Jack

Connect headphones here.

MEMO

When headphones are connected to the PHONES jack, tonal adjustments are applied so the sound is close to that produced by a guitar amp.

4. EXT LOOP SEND RETURN Jacks

Connect to external effects processor or amp.

5. AMP CONTROL Jack

When using the AMP CONTROL function (p. 132), connect to the jack used for switching guitar amp channels.

6. EXP PEDAL/CTL 3, 4 Jack

Connect an optional expression pedal (such as the Roland EV-5) or footswitch (such as the BOSS FS-6) here (p. 22).

7. USB Connector

Use a USB cable to connect a computer to this connector and enable exchange of data between the GT-10 and the computer (p. 90).

8. DIGITAL OUT Connector

Outputs digital audio signals (p. 66).

9. MIDI IN/OUT Connectors

Connect an external MIDI device to these connectors to transmit and receive MIDI messages (p. 79).

10. POWER Switch

Turns the power on and off.

11. DC IN (AC Adaptor) Jack

Connect the included AC adaptor here.

* To prevent damaging the GT-10, please be sure not to use any AC adaptor other than the one included with the GT-10.

12. Cord Hook

Hook the AC adaptor cord here to prevent the adaptor plug from being disconnected (p. 22).

* Disconnecting the AC adaptor while the GT-10 is in use may result in corruption of important data.

13. Security Slot ()

Connect a commercially available anti-theft security cable here.

<http://www.kensington.com/>

Quick Guide

The Quick Guide describes required settings and basic operations. For detailed descriptions of operations, refer to the explanations in chapter 1 and after.

Getting Ready

1 Connect the Guitar and Amp

1. Connect the guitar and the guitar amp.

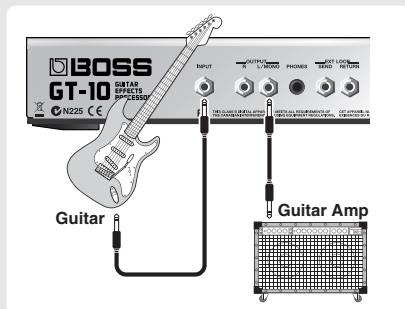

cf.

For detailed information on how to make the connections, refer to “Making the Connections” (p. 22).

Before turning on the power, confirm the following.

- Are all external devices properly connected?
- Is the volume on the GT-10, your amp, and all other connected devices turned down to the minimum level?

NOTE

Raise the amp volume only after turning on the power to all connected devices.

2 Turn On the Power

NOTE

Once the connections have been completed, turn on power to your various devices in the order specified. By turning on devices in the wrong order, you risk causing malfunction and/or damage to speakers and other devices.

1. Insert the DC plug on the AC adaptor into the DC IN jack on the GT-10.



2. Plug the AC adaptor into a power outlet.

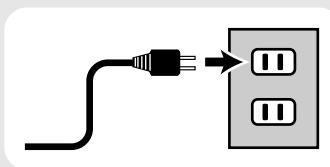

3. Use the POWER switch to switch on the power.

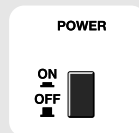

4. Power up the guitar amp.

cf.

For information on how to switch off the power, refer to “Turning Off the Power” (p. 25).



3 Adjust the Volume

Use the OUTPUT LEVEL knob to adjust the volume level.

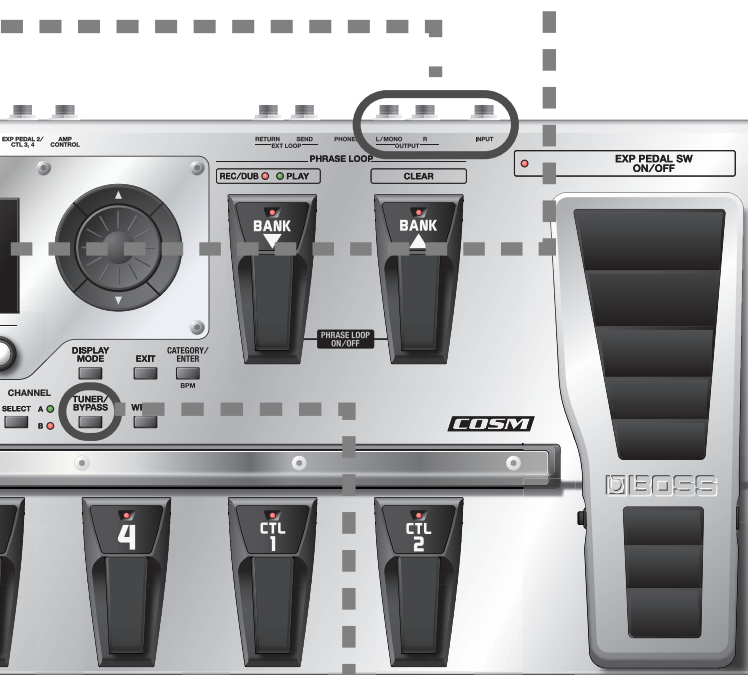

Tune the Guitar

Each press of the TUNER/BYPASS button switches the Tuner feature on or off. Switching on the Tuner feature enables direct output of input sounds (bypass), and lets you tune the guitar while in this state. For more information, refer to "Tuning the Guitar (TUNER)" (p. 26).

Examples of Connections Using the SEND/RETURN Jacks

Example 1: Using an External Effects Unit
This enables use as one of the GT-10's effects.

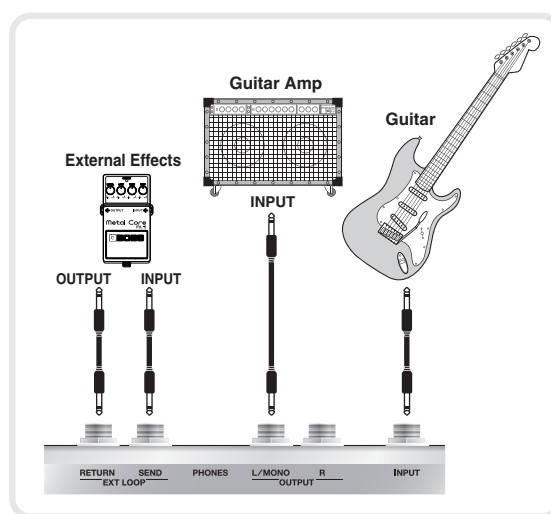

Example 2: Using Send and Return on the Guitar Amp

This allows you to switch between use of the GT-10 and the guitar amp's preamp.

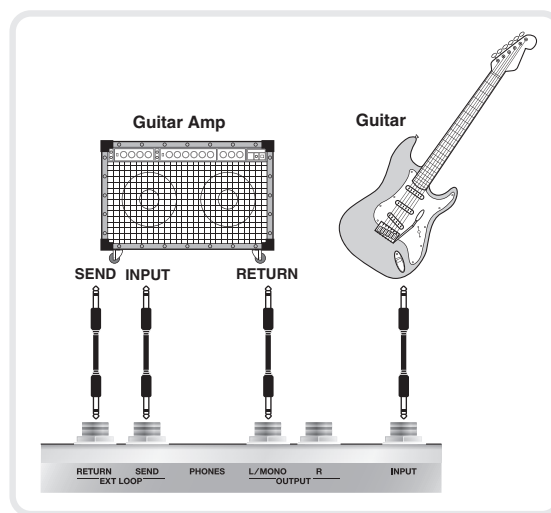

* When you're making connections using the SEND/RETURN jacks, you also need to make settings for the "SEND/RETURN" (p. 132).

Playing Sounds

Once you've finished getting ready to play, try playing sounds as you operate the GT-10.

Choosing a Patch in the Current Bank

Choose the patch you want to use by depressing the corresponding number pedal.



The indicator for the number pedal you pressed lights up and the patch is switched.

Choosing a Patch in a Different Bank

1. Press the BANK pedals to select the desired bank.

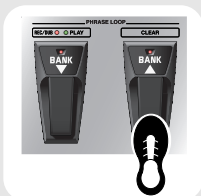

The GT-10 stands by for specification of the patch number, and the number pedal indicators blink.

2. Choose the patch you want to use by depressing the corresponding number pedal.

The indicator for the number pedal you pressed lights up and the patch is switched.

NOTE

If you're not at the Play screen (p. 23), you won't be able to switch patches. Press the [EXIT] button to go back to the Play screen, then choose the patch.

MEMO

You can also use the BANK pedals to operate the Phrase Loop feature. Phrase Loop is a feature that lets you record a performance and play it back as a loop. For more information, refer to "Phrase Loop Play" (p. 58).

About the Bank and Number Display

The display on the left side shows the bank, and the display on the right side shows the bank and patch number.

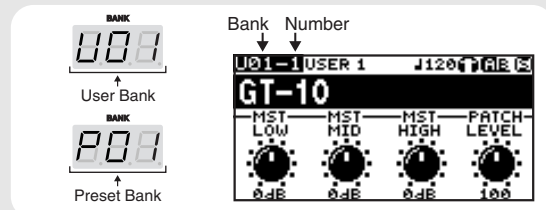

What is a Patch?

A combination (or set) of effects together with a group of parameter settings is called a "patch." The GT-10 can store 400 different patches in memory, organized by bank and number as shown below.

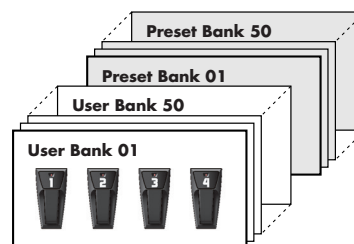

Patches include User patches, which you can use to save the settings for newly created effects, and Preset patches, for which modified settings cannot be saved. For more information, refer to "Selecting a Tone (Patch Change)" (p. 29).

Switch the Patch with the Dial

When you're at the Play screen (p. 23), turning the dial switches the patch.



Working with Effects Using the Pedals

The EXP Pedal and the CTL 1 and 2 pedals can be set to use in switching effects on or off for individual patches, use as a volume pedal, and other such operations.

Executing these operations during a performance lets you modify the sound more effectively.

	<p>Press the CTL 1 pedal. The CTL1 pedal function is switched on. (The indicator for the CTL 1 pedal lights up.) Press a second time to switch off. (The indicator for the CTL 1 pedal goes out.)</p>
	<p>Press the CTL 2 pedal. The CTL2 pedal function is switched on. (The indicator for the CTL 2 pedal lights up.) Press a second time to switch off. (The indicator for the CTL 2 pedal goes out.)</p>
	<p>Press the toe of the EXP Pedal. The EXP Pedal value rises.</p> <p>Press the heel of the EXP Pedal. The EXP Pedal value decreases.</p>
	<p>Press the toe of the EXP Pedal firmly. The EXP PEDAL SW function is switched on. (The EXP PEDAL SW ON/OFF indicator lights up.) Press firmly a second time to switch off. (The EXP PEDAL SW ON/OFF indicator goes out.)</p>

cf.

You can assign the parameters you want to the EXP Pedal, EXP PEDAL SW and the CTL 1 and 2 pedals and operate them accordingly. For more information, refer to "Using Pedals to Control the Parameters" (p. 47)."

Editing

Basic Operation

This describes the basic operations you use when editing settings.

1 Access the System Menu screen.

2 Choose the menu item.

* In this example, "PATCH EDIT" icon is selected.

3 The setting screen for the selected item appears.

* If you want to next menu item further, repeat Steps 2 and 3.

TIP Buttons and Knobs You Use

- These set the parameter value.
- Changes the page.
- Chooses an item.
- This confirms the selected item.
- This quits making settings.

This displays the System Menu.

Sets the parameter value.

Creating Sounds Based on Existing Patches

Let's try creating a new sound based on a patch whose sound is close to what you want to make.

Switching Effects On and Off

1. Choose a patch whose sound is close to the sound you want to create (p. 16).

2. Choose the effect you want to switch on or off.

cf. For more information about each parameter, refer to "Chapter 8 Parameters Guide" (p. 96).

3. Again press the button you pressed in step 2. The effect is switched on or off. Effect on: button illuminated. Effect off: button extinguished.

TIP Buttons and Knobs You Use

These set the parameter value.

These choose the effect.

4 Change the parameter settings.

Example 1

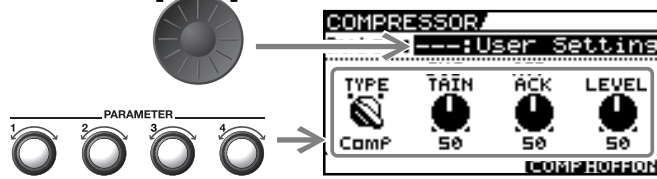

Example 2



5 Quit the settings.
(Go back to the previous screen.)

EXIT



TIP

DISPLAY MODE



Each press this button switches between Knob View and List View.

Only the major parameters are shown in Knob View, you can adjust the parameters quickly. If you want to have all parameters appear, switch to List View.

Adjusting Effect Parameters

1. Switch on the effect you want to adjust.

2. Adjust the parameters for the effect.

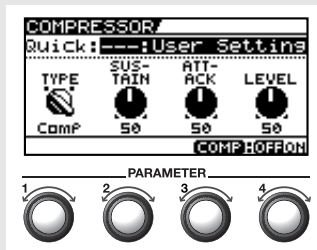

cf.

For more information about each parameter, refer to "Chapter 8 Parameters Guide" (p. 96).

3. Repeat steps 1 and 2 until you obtain the sound you want.

NOTE

If you switch patches, all settings that have been made will be lost. To save the sound you've created, carry out the Write procedure (p. 42).

Creating Sounds with Ease

Using the EZ Tone feature (p. 32) lets you quickly find settings close to the musical genre and feel of the song you want to create, and enables you to create the sound easily. Let's try creating sounds using EZ Tone.

1 Make the Settings for the Pickup and the Output Equipment

Make the settings matched to the guitar and output equipment you're using.

cf.
For more information about each parameter, refer to "STEP1: SETTING" (p. 133).

2 Choose the Basic Tone

Use the basic tones and variations to choose the musical genre and the feel of the song.

cf.
For more information about each parameter, refer to "STEP2: TONE" (p. 134).

TIP

Buttons and Knobs You Use

This starts the EZ Tone feature.
These set the parameter values.



These change the page.

3 Adjust the Distortion

Using Tone Grid, adjust the distortion until you get the sound you want.

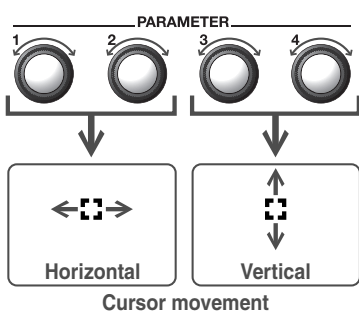
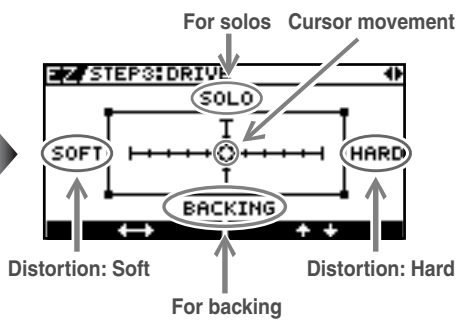

4 Adjust the Other Effects

Using Tone Grid, adjust the effects until you get the sound you want.

Ex. When you adjust the Delay

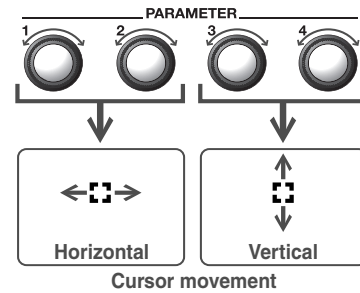
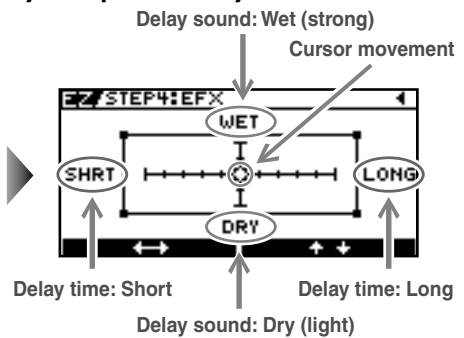

NOTE

If you switch patches, you'll lose all the settings you've made. To save the sound you've created, carry out the Write procedure (p. 42).

TIP

You can take parameters you've adjusted with EZ TONE CREATE and fine-tune them further using EZ TONE EDIT or parameter operations. For more information, refer to "Adjusting the Tone (Edit)" (p. 33).

Chapter 1 Playing Sounds

Making the Connections

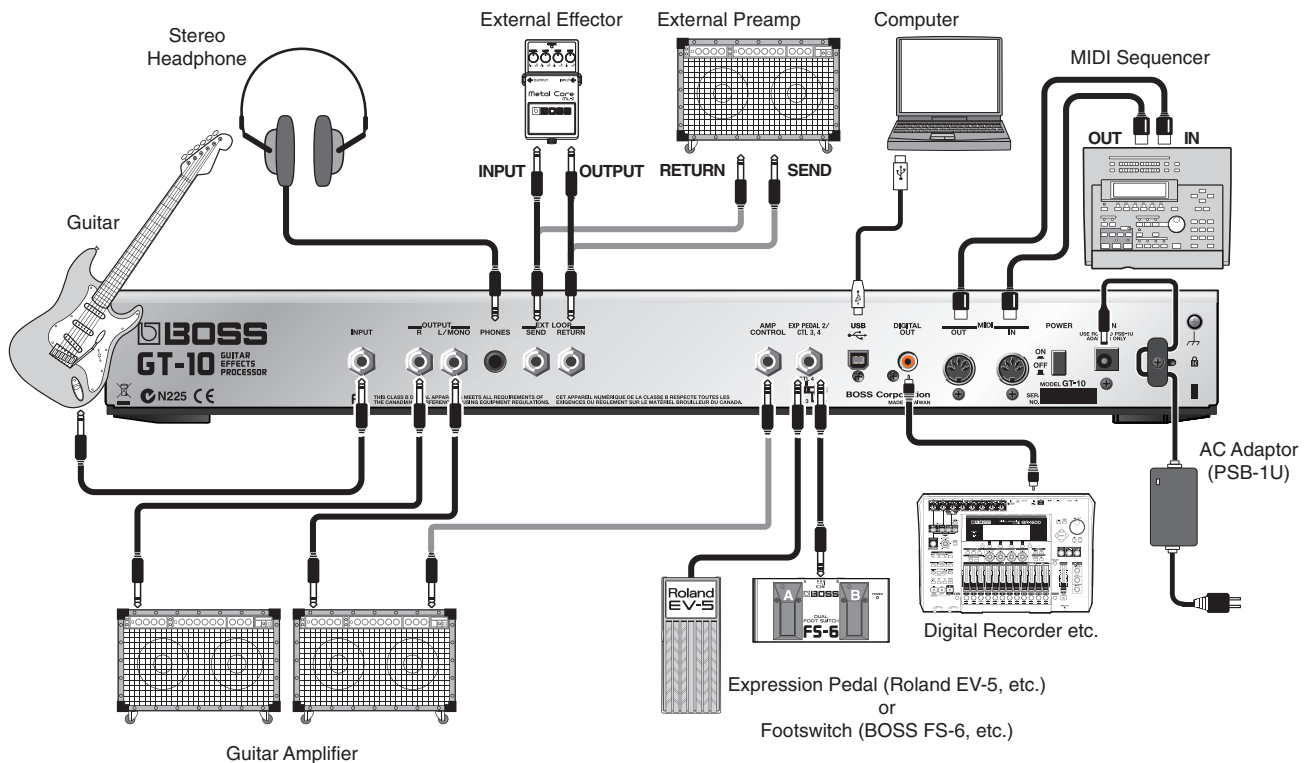

NOTE

- To prevent malfunction and/or damage to speakers or other devices, always turn down the volume, and turn off the power on all devices before making any connections.
- Raise the amp volume only after turning on the power to all connected devices.
- When connection cables with resistors are used, the volume level of equipment connected to the INPUT jack may be low. If this happens, use connection cables that do not contain resistors.
- When outputting in mono, connect the cable to the OUTPUT L/MONO jack.
- Use only the specified expression pedal (Roland EV-5 or BOSS FV-500L; sold separately). By connecting any other expression pedals, you risk causing malfunction and/or damage to the unit.
- Depending on the circumstances of a particular setup, you may experience a discomforting sensation, or perceive that the surface feels gritty to the touch when you touch this device, microphones connected to it, or the metal portions of other objects, such as guitars. This is due to an infinitesimal electrical charge, which is absolutely harmless. However, if you are concerned about this, connect the ground terminal (see figure) with an external ground. When the unit is grounded, a slight hum may occur, depending on the particulars of your installation. If you are unsure of the connection method, contact the nearest Roland Service Center, or an authorized Roland distributor, as listed on the "Information" page.

Unsuitable places for connection

- Water pipes (may result in shock or electrocution)
- Gas pipes (may result in fire or explosion)
- Telephone-line ground or lightning rod (may be dangerous in the event of lightning)



- Place the AC adaptor so the side with the indicator (see illustration) faces upwards and the side with textual information faces downwards. The indicator will light when you plug the AC adaptor into an AC outlet.

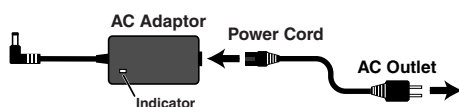

MEMO

- To prevent the inadvertent disruption of power to your unit (should the plug be pulled out accidentally), and to avoid applying undue stress to the AC adaptor jack, anchor the power cord using the cord hook, as shown in the illustration.



- When connecting an expression pedal to the EXP PEDAL2/CTL 3,4 jack, set the minimum volume for the connected expression pedal to the "MIN" position.
- When connecting a BOSS FS-6 footswitch (optional) to the EXP PEDAL 2/CTL 3,4 jack, set the MODE switch and POLARITY switch as shown below.

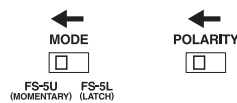

- When connecting a BOSS FS-5U footswitch (optional) to the EXP PEDAL 2/CTL 3,4 jack, set the POLARITY switch as shown below.

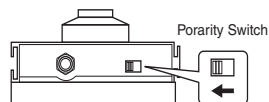

- You can use the special (optional Roland) PCS-31 connector cord to connect two footswitches.

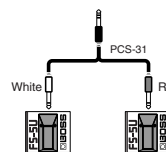

cf.

- When using the unit with an expression pedal or a footswitch (the optional FS-6 or FS-5U) connected to the EXP PEDAL 2/CTL 3,4 jack, make the settings given on "Using Pedals to Control the Parameters" (p. 47).
- For more on using the AMP CONTROL jack, refer to "AMP CONTROL" (p. 132).

Turning on the Power

Before turning on the power, confirm the following.

- Are all external devices properly connected?
- Is the volume on the GT-10, your amp, and all other connected devices turned down to the minimum level?

NOTE

Once the connections have been completed, turn on power to your various devices in the order specified. By turning on devices in the wrong order, you risk causing malfunction and/or damage to speakers and other devices.

The display changes, showing the following. The screen that appears at this point is called the “Play screen.”

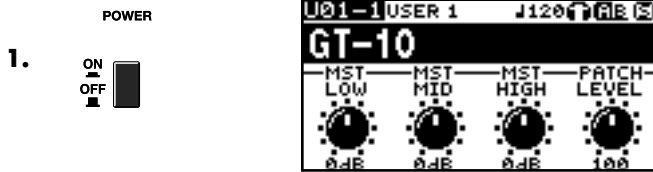

MEMO

- Upon power-up, the patch most recently selected when the power was last turned off is selected.
- This unit is equipped with a protection circuit. A brief interval (a few seconds) after power up is required before the unit will operate normally.
- The explanations in this manual include illustrations that depict what should typically be shown by the display. Note, however, that your unit may incorporate a newer, enhanced version of the system (e.g., includes newer sounds), so what you actually see in the display may not always match what appears in the manual.

2. Turn on the power to any external effects processors → the guitar amp (power amp).

The Icons in the Play Screen

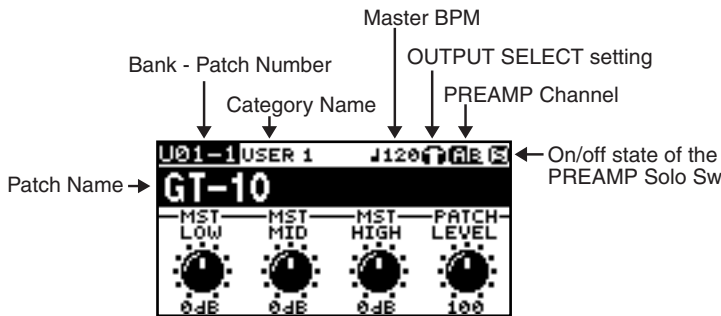

J120	Displays the Master BPM (p. 122) value for each patch.	
ABE	When the PREAMP Ch.Mode is set to Single, preamp channel A is selected.	When the PREAMP Ch.Mode is set to Dynamic, the display switches between A and B according to the input level.
AB	When the PREAMP Ch.Mode is set to Single, preamp channel B is selected.	
AB	This is displayed when the PREAMP Ch.Mode is set to Dual Mono or Dual L/R.	
☐	This is displayed when the PREAMP Solo Sw is Off.	
Ⓢ	This is displayed when the PREAMP Solo Sw is On.	

cf.

For details on the OUTPUT SELECT icons, refer to “Making Settings for a Connected Device (Output Select)” (p. 24).

Switching the Play Screen

The GT-10 has a variety of Play screen variations. You can switch the information shown in the Play screen by pressing  .

MEMO

- You can use the PARAMETER knobs 1 through 4 to work with the values of the parameters displayed at the bottom of the Play screen. Also, for each parameter, you can change the corresponding assignment at the SYS KNOB ASSIGN screen (p. 46).
- The parameter name displayed at the each Play screen is abbreviated. For details about parameter names, refer to “Parameters You Can Set with PDL:CTL/EXP” (p. 125) or “Display of Parameters You Can Set with SYS KNOB SETTING” (p. 138).

Screen 1

This displays the name of the patch and the parameters you can work with using the PARAMETER 1 through 4 controls.

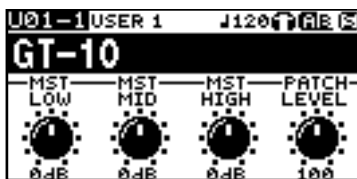

Screen 2

The patch name is displayed, along with the patch's preamp selections and an icon for the preamp channel that's currently in use.





Screen 3

This screen displays the preamp channel mode and the preamp that's in use.



Screen 4

This screen displays the functions assigned to CTL 1 and 2, the EXP PEDAL SW, and the EXP Pedal.

* About the S icon and A icon displayed at the Screen 4 and 5.	
	The S icon displays when the Pedal Function is enabled (p. 47).
	The A icon displays when the Patch Assign Function is enabled (p. 50).



Screen 5

This screen displays the functions assigned to the Number Pedal Switch, CTL 3 and 4, the external expression pedal (EXP PEDAL2).



Screen 6

This is the screen shown when you're in Manual mode (p. 55). Manual mode is enabled only while this screen is displayed. Pressing [CATEGORY/ENTER] in this screen allows you to make settings for MANUAL MODE SETTING.



Screen 7

The effects used, as well as their connection sequence (CHAIN) in a channel is indicated.



Screen 8

The patch name and the output level meter are displayed.



Adjusting the Output Level

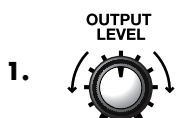

Adjust the GT-10's output level with the OUTPUT LEVEL knob.

Making Settings for a Connected Device (Output Select)

Select the type of device connected to the OUTPUT jack.

MEMO

To derive the maximum performance from the GT-10, be sure to make the correct setting for OUTPUT SELECT, the one that's most suitable for your setup.

- The speaker simulator (p. 99) is enabled only when OUTPUT SELECT is set to LINE/PHONES.
- You cannot change the tone with Output Select when PREAMP On/Off (p. 98) is set to Off.

The OUTPUT SELECT settings screen appears.

1. 



2. 

Move the cursor to Mode.

3. 

Set the Mode.



Value	Explanation
Patch	This uses the patch's Output Select setting. You can use a different output setting for each individual patch.
System	This uses the system's Output Select setting. The same output setting is used for all patches.

4. 

Move the cursor to Select.

5. 

Choose the operation for the Select parameter.

Value	Explanation	Icon displayed on the Play screen
JC-120	Use this setting when connecting to Roland's JC-120 guitar amp.	
SMALL AMP	Use this setting when connecting to small guitar amp.	
COMBO AMP	Use this setting when connecting to the guitar input of a combo amp other than the JC-120 guitar amp (where the amp and speaker or speakers are combined in a single unit). * Depending on your guitar amp, you may be able to obtain good results with the "JC-120" setting.	
STACK AMP	Use this setting when connecting to the guitar input of a stack-type guitar amp (where the amp and speaker or speakers are separated).	
JC-120 Return	Use this setting when connecting to the RETURN jack of a JC-120.	
COMBO Return	Use this setting when connecting to the RETURN jack with a combo amp.	
STACK Return	Use this setting when connecting to the RETURN jack of a stack amp or rack mounted power amp.	
LINE/PHONES	Use this setting when using headphones or when connecting to a multi-track recorder for recording. * When using the speaker simulator, set this to LINE/PHONES.	

Chapter 1 Playing Sounds

Turning Off the Power

Before turning off the power, confirm the following.

- Is the volume on the GT-10, your amp, and all other connected devices turned down to the minimum level?

1. Turn off the power to the guitar amp (power amp) → any external effects processors and other devices.

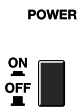
2.  Turn the GT-10's power off.

Tuning the Guitar (TUNER)

When the Tuner is turned on, sounds input to the GT-10 are output directly as is (bypassed), and the tuner is activated.

Under these conditions you can then tune your guitar.

Turning the Tuner Function On and Off

1.  The tuner is switched on or off.

About the Display During Tuning

With the GT-10's internal tuner, the Note Name and the Tuning Guide are shown of the display, indicating the difference between the input sound and the sound in the display.

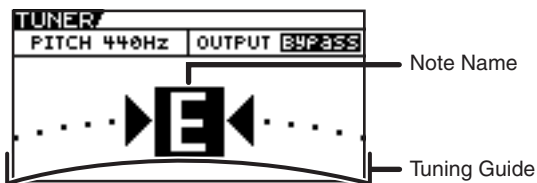

When the difference from the correct pitch falls within 50 cents, the Tuning Guide then indicates the size of that difference. As you watch the Tuning Guide, tuning until the center indicator lights up.

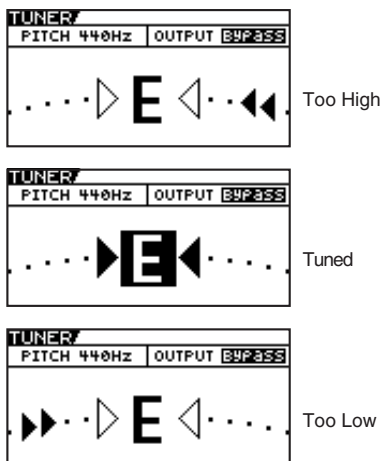

How to Tune

1. Play a single open note on the string being tuned. The Note Name closest to the pitch of the string that was played appears in the display.

MEMO

Only play a single note on the one string being tuned.

2. Tune the string until the string name appears in the display.



TIP

General Tuning

	7th	6th	5th	4th	3rd	2nd	1st
Regular	B	E	A	D	G	B	E
1/2 Step Down	A [♯]	D [♯]	G [♯]	C [♯]	F [♯]	A [♯]	D [♯]

3. Keep checking the Tuning Guide, tuning until the center indicator lights up.



TIP

When tuning guitars equipped with a tremolo bar, when one string is tuned, the others may end up being out of tune. In this case, tune to the pitch indicated by the initial note name, then tune the other strings again, repeatedly fine-tuning each string.

4. Repeat Steps 1–3 until all of the strings are tuned.

Changing the Tuner Settings (Tuner Pitch)

1.  Turn on the Tuner.

2.  Move the cursor to PITCH.

3. Change the reference pitch.

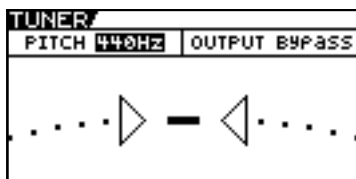



MEMO

- The frequency of A4 (the middle A on a piano keyboard) played by an instrument (such as a piano) that provides the pitch to which the other instruments refer in tuning before a performance begins is called the reference pitch.
- This is set to 440 Hz when shipped from the factory.

Range	Explanation
435Hz–445Hz	This sets the reference pitch.

Changing the Tuner Settings (Tuner Out)

-  Turn on the Tuner.
-  Move the cursor to OUTPUT.

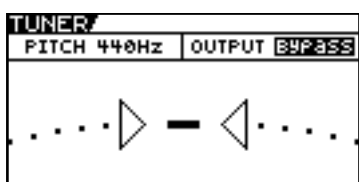
-  Select the output while Tuner is on.
 

MEMO

- When OUTPUT is set to "Bypass," and Tuner is set to ON, you can adjust the volume of the direct sound by operating the EXP Pedal.
- OUTPUT is set to "Bypass" when shipped from the factory.

Value	Explanation
Bypass	Sounds input to the GT-10 bypass the processing and are output directly as is.
Mute	Sounds are muted, and no sound is output.

TIP

Switching the Tuner On and Off with the CTL Pedal

By setting the CTL Pedal function (p. 47) to "Tuner," you can switch the tuner on and off with one of the CTL pedals.

Switching the Tuner On and Off by Lifting Up on the EXP Pedal

When the EXP Pedal is functioning as a Foot Volume control, set one of the ASSIGN 1-8 Assign Variable settings (p. 50) as follows.

With these setting, you can switch on the Tuner by drawing back the EXP Pedal.

Target:	Tuner Sw	Src Mode:	Moment
Min:	On	ActRngLo:	0
Max:	Off	ActRngHi:	1-127
Source:	EXP1 PEDAL		

Switching the Tuner On and Off with the Number Pedal

Set the Num Pdl Sw function (p. 57) to Tuner to switch the tuner on and off with the number pedal of the current patch.

Selecting a Tone (Patch Change)

What is a Patch?

A combination (or set) of effects together with a group of parameter settings is called a “patch.” The GT-10 can store 400 different patches in memory, organized by bank and number as shown below.

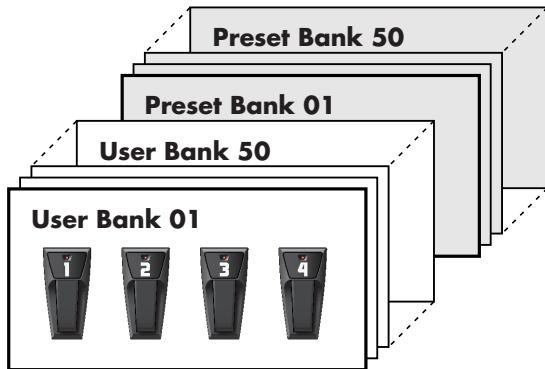

User Banks (U01-U50)

Newly created effects settings are saved in the User banks. Patches in these banks are called “User patches.” A “U” appears in the display when a User patch is selected.

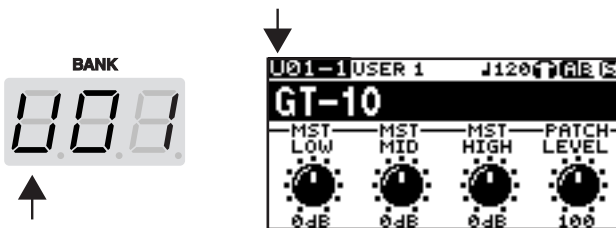

Preset Banks (P01-P50)

The Preset banks contain effect settings that make full use of the features the GT-10 has to offer. The patches in these banks are called “Preset patches.” When you change the settings of a Preset patch, save the result as a User patch. Preset patches cannot be overwritten.

A “P” appears in the display when a Preset patch is selected.

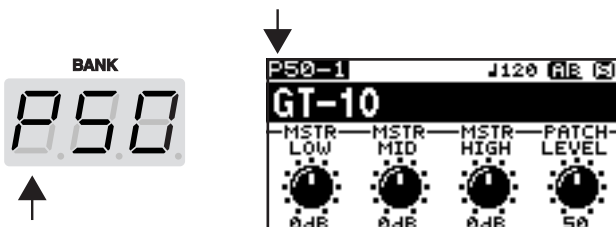

Using the Pedal to Select the Patch

Patches are switched by selecting a “bank” (U01–U50, P01–P50) and “number” (1-4). The bank and number appear in the GT-10’s display as shown in the following figure.

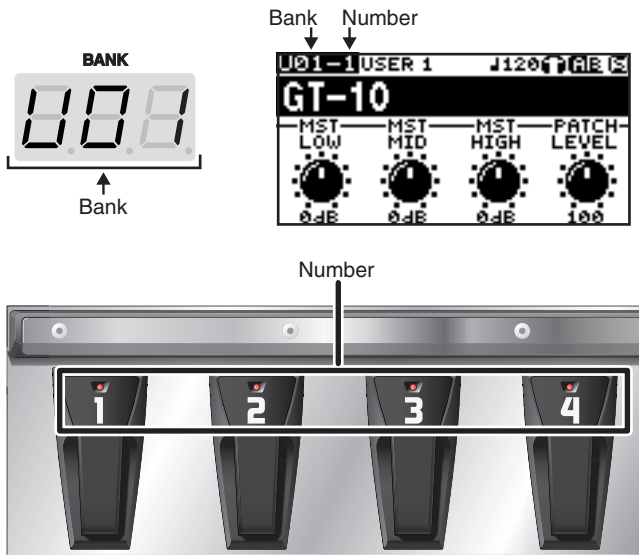

MEMO

- When selecting a patch, even if a new bank is selected, the patch is not switched until you also choose the number. If you want to be able to switch patches merely by selecting a different bank, adjust the Bank Change mode (p. 72) setting.
- You can also set the unit so certain effects continue to be used with a following patch after you switch patches. For details, refer to “Keeping Effect Sounds Playing After Patches Are Switched (Patch Change Mode)” (p. 68).

Choosing a Patch in the Same Bank



1.

Choose the number of the patch you want to use.

MEMO

- The indicator for the selected number pedal lights up.
- On the GT-10, you cannot switch patches in any screen other than the Play screen. Press [EXIT] to return to the Play screen (p. 24).

Choosing a Patch in a Different Bank



1.

Select the bank.

MEMO

Press the BANK pedals to select the desired bank. After bank selection, the GT-10 stands by for specification of the patch number, and the number pedal indicators light up.



2.

Choose the number of the patch you want to use.

MEMO

- The indicator for the selected number pedal lights up.
- On the GT-10, you cannot switch patches in any screen other than the Play screen. Press [EXIT] to return to the Play screen (p. 24).

Using the Dial to Select the Patch

- 

Select the Patch.

MEMO

On the GT-10, you cannot switch patches in any screen other than the Play screen. Press [EXIT] to return to the Play screen (p. 24).

Separating Patches into Groups (CATEGORY)

The GT-10 includes a function that allows you to categorize patches into a number of different groups. This is called the CATEGORY function (p. 39). Specifying the category for each patch makes searching for patches more convenient.

- 

The CATG screen appears.
The categories and the patches in these categories are shown in list format.

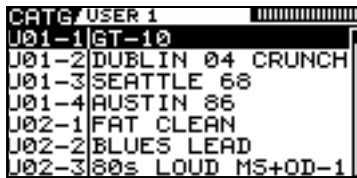

MEMO

- On the GT-10, you cannot switch patches in any screen other than the Play screen. Press [EXIT] to return to the Play screen (p. 24).
- You can also display the CATG screen from PATCH SEARCH in the SYSTEM screen.

- 

Select the category.

- 

The GT-10 switches to the selected patch.

Adjusting a Tone

On the GT-10, the master equalizer parameters are assigned to the PARAMETER knobs of the Play screen by default. You can use these PARAMETER knobs to adjust the sound quality globally, for all patches.

- 

Select the Patch.

- 

P1 knob: Adjust the low frequency range tone.
P2 knob: Adjust the middle frequency range tone.
P3 knob: Adjust the high frequency range tone.

Chapter 2 Creating Sounds (Patch Edit)

Creating Sounds with Ease (EZ TONE)

Creating a Tone for the Song You Envision (Create)

If you already have a clear idea about the kind of sound you want to create, you can save yourself a lot of trouble by starting out with a patch that is relatively similar to what you have in mind, then tweak its settings until you arrive at what you want. EZ TONE CREATE lets you create sounds easily by choosing settings close to the musical genre and the feel of the song you want to compose.

The SETTING screen for EZ TONE CREATE appears.



2.  P1, P2 knob: This selects the pickup type.
P3, P4 knob: This selects the equipment connected to the GT-10.

The TONE screen for EZ TONE CREATE appears.



4.  P1, P2 knob: This selects the basic tone.
P3, P4 knob: This selects a variation.

The DRIVE Tone Grid for EZ TONE CREATE appears.

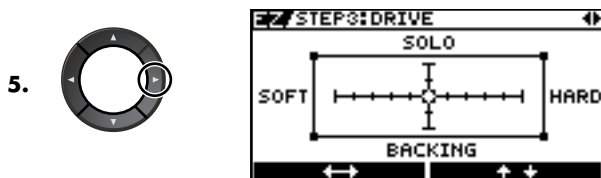

6.  P1, P2 knob: This adjusts the distortion (DRIVE).
P3, P4 knob: This adjusts the volume level of the distortion.

The EFX Tone Grid for EZ TONE CREATE appears.

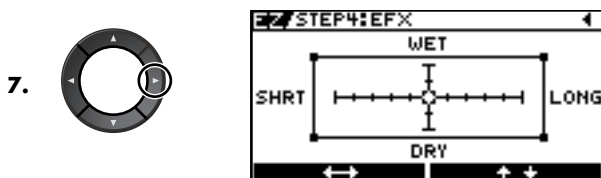

8.  Adjust the effects until you get the sound you want.
(Ex.) When you adjust the Delay effect
P1, P2 knob: Adjusts the delay time.
P3, P4 knob: Adjusts the volume level of the delay.

NOTE

Switching patches causes all settings that have been made to be lost. To save the sound you've created, carry out a Write operation (p. 42).

MEMO

You can take parameters you've adjusted with EZ TONE CREATE and fine-tune them further using EZ TONE EDIT or parameter operations. For more information, refer to "Adjusting the Tone (Edit)" (p. 33).

Adjusting the Tone (Edit)

By using EZ TONE EDIT you can adjust the sound of a patch with ease, without having to manipulate complicated parameters.

The EZ TONE EDIT screen appears.

1.

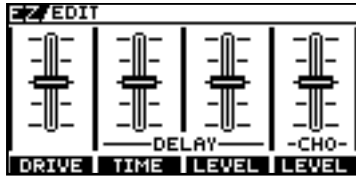

2.



- P1 knob: Adjusts the distortion (DRIVE).
- P2 knob: Adjusts the delay time.
- P3 knob: Adjusts the volume level of the delay.
- P4 knob: Adjusts the volume level of the chorus.

Setting the Effects

Turning an Effect On and Off

The GT-10's internal effects are switched on and off with button controls. When an effect is switched on, the button's indicator lights up; the indicator goes out when the effect is off.

MEMO

[MASTER/PEDAL FX] does not light up.

The setting screen for the effects appears.

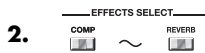
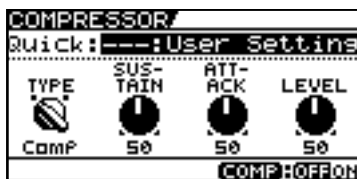
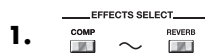

(Press the button you pressed in step 1 a second time.)
The effect is switched on or off.

3. To select another effect to be switched on and off, repeat Steps 1 and 2.

MEMO

- With [FX-1] and [FX-2], the settings for the currently selected effect are shown.
- Pressing [MASTER/PEDAL FX] displays the MST/PDL FX screen.

MEMO

- If you want to name the patch or edit the name, proceed to "Naming a Patch (PATCH NAME)" (p. 41) before you save.
- If you want to save a tone with the settings you've made, proceed as described in "Saving a Patch (PATCH WRITE)" (p. 42).

On/Off Operations Using the PARAMETER Knobs

You can use the P1 through P4 knobs to switch on or off the effects whose icons are displayed in the PATCH EDIT screen or MST/PDL FX screen.

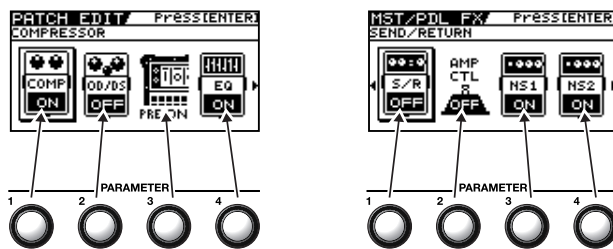

Setting the Effects Simply (Quick Setting)

Each effect includes prepared sample settings called "Quick Settings."

You can easily create new effect sounds just by selecting and combining these Quick Settings.

The setting screen for the effects appears.

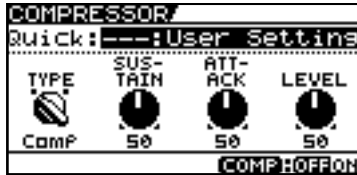
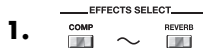

MEMO

- With FX-1 and FX-2, the settings for the currently selected effect are shown.
- Pressing [MASTER/PEDAL FX] displays the MST/PDL FX screen.
- "---: User Setting" indicates that the effect indicated in the display is set to be saved to the currently selected patch, or that the settings are currently being modified.

Select the Quick Setting you want.

U*: User Quick Setting
P*: Preset Quick Setting

MEMO

For PREAMP, the various FX-1 or FX-2 effects, or the ASSIGN 1 through 8 Quick Settings, you can call up the respective settings described below.

- PREAMP (You can call up settings separately for channel A and B.)
U01-1.A – U50-4.B: User Patch Setting
P01-1.A – P50-4.B: Preset Patch Setting
- Each effect of the FX-1 or FX-2 (You can call up settings separately for FX1 and FX2.)
U01-1.1 – U50-4.2: User Patch Setting
P01-1.1 – P50-4.2: Preset Patch Setting
- ASSIGN (You can call up settings separately for ASSIGN 1 through 8)
U01-1.1 – U50-4.8: User Patch Setting
P01-1.1 – P50-4.8: Preset Patch Setting



MEMO

- When FX-1 or FX-2 has been selected in Step 1, the settings for the effect selected by means of the FX1/FX2 Select parameter (p. 102) are switched.
- When PREAMP has been selected in Step 1, you can choose different of settings for channel A and B.
- If you want to name the patch or edit the name, proceed to "Naming a Patch (PATCH NAME)" (p. 41) before you save.
- If you want to save a tone with the settings you've made, proceed as described in "Saving a Patch (PATCH WRITE)" (p. 42).

Switching Between Knob View and List View

You can switch the setting screen for effects between a knob-format view and a list-format view.

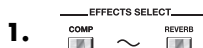

The setting screen for the effects appears.

Each press switches between Knob View and List View.

Only the major parameters are shown in Knob View, you can adjust the parameters quickly. If you want to have all parameters appear, switch to List View.



MEMO

With [FX-1] and [FX-2], the settings for the currently selected effect are shown.

Adjusting the Parameters

Each effect comprises several different kinds of parameters. You can more precisely create the sounds you want by editing each of these parameters individually.

The setting screen for the effects appears.

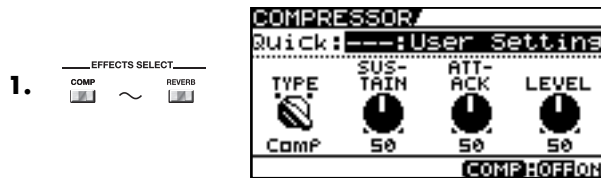

MEMO

- With [FX-1] and [FX-2], the settings for the currently selected effect are shown.
- Pressing [MASTER/PEDAL FX] displays the MST/PDL FX screen.



MEMO

Some effects include multiple pages for the parameter settings. You can use [◀] and [▶] to switch the pages.

3. To adjust another effect parameter, repeat Steps 1 and 2.

MEMO

- If you want to name the patch or edit the name, proceed to “Naming a Patch (PATCH NAME)” (p. 41) before you save.
- If you want to save a tone with the settings you’ve made, proceed as described in “Saving a Patch (PATCH WRITE)” (p. 42).

Operations Using the PARAMETER Knobs

In the effects screens, the knobs correspond to the displayed parameters.

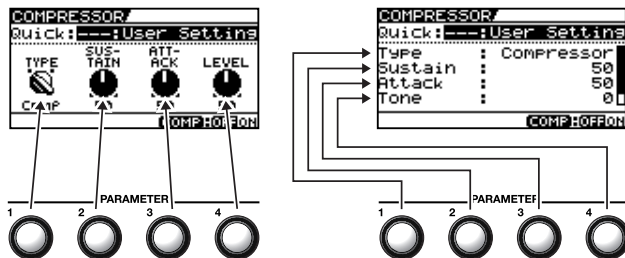

Selecting TYPE for OD/DS or PREAMP

Changing the OD/DS or PREAMP screen to Knob View lets you make the selection for TYPE using the P1 knob and [▼] and [▲].

The TYPE values for OD/DS and PREAMP are grouped into several categories.



P1 knob: This selects the general category for OD/DS (or PREAMP).

[▼] and [▲]: These select the TYPE value within the category.

cf. →

For details, refer to “Chapter 8 Parameters Guide” (p. 96).

Adjusting EQ (Equalizer)

In the EQ screen, using [DISPLAY MODE] to switch the screen lets you check the current status of the settings by means of a graph.

Use [◀] and [▶] to switch pages, and use the P1 through P4 knobs to adjust the respective parameters.

TIP

You can use the same technique to adjust the various parameters under PARA EQ for FX-1 and FX-2 as well.

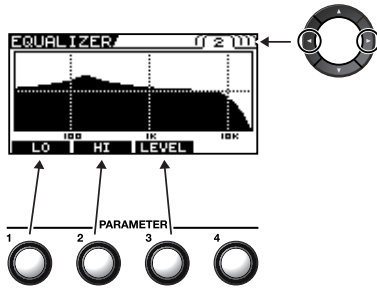

cf.

For details, refer to "Chapter 8 Parameters Guide" (p. 96).

Adjusting GRAPHIC EQ for FX-1/2

In the GRAPHIC EQ screen for FX-1 or FX-2, using [DISPLAY MODE] to switch the screen lets you check the current status of the settings by means of a slider view.

Use [◀] and [▶] to select the range you want to adjust, and use the P1 through P4 knobs to adjust the respective parameters.

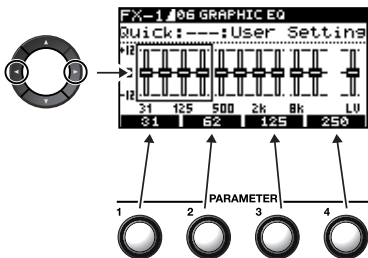









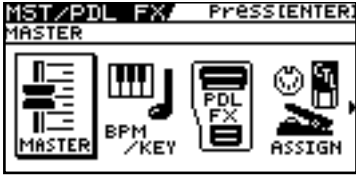

cf.

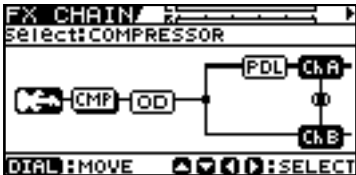
For details, refer to "Chapter 8 Parameters Guide" (p. 96).

Changing the Connection Order of Effects (Effect Chain)

Here's how you can change the order in which the effects are connected.

<p>1. </p>	<p>The MST/PDL FX screen appears.</p> 	
<p>2. </p>	<p>Select FX CHAIN.</p> 	
<p>3. </p>	<p>The FX CHAIN screen appears.</p> 	<p>MEMO</p> <p>The icon displayed on the FX CHAIN screen indicates the status as described below.</p> <ul style="list-style-type: none">  : Effect on  : Effect off  : Selected effect (movable)  : Selected effect (not movable)
<p>4. </p>	<p>Select an effect you want to move.</p> <p>TIP</p> <p>Pressing the effect button for the effect you want to move lets you choose the effect.</p>	<p>MEMO</p> <ul style="list-style-type: none"> • Pressing [CATEGORY/ENTER] or the EFFECTS SELECT button for the currently selected effect switches the effect on or off. • You can choose effects on channel A (upper) or channel B (lower) by using [▼] and [▲] to switch between them. • There are two effect routes—PREAMP channel A and channel B—and [CHANNEL SELECT] is used to select which one to use.
<p>5. </p>	<p>Move an effect to the point where you want to have an effect inserted.</p>	<p>MEMO</p> <p>Channel A and channel B cannot be moved.</p>
<p>6. If you want to change the sequence further, repeat Steps 4 and 5.</p>		<p>MEMO</p> <ul style="list-style-type: none"> • If you want to name the patch or edit the name, proceed to “Naming a Patch (PATCH NAME)” (p. 41) before you save. • If you want to save a name of the patch with the settings you’ve made, proceed to “Saving a Patch (PATCH WRITE)” (p. 42).

Checking the Effect Level with the Level Meter

In the upper right of the FX CHAIN screen, you can meter the output level of each effect.

To check an effect's output level, move the cursor to the desired effect.

MEMO

You can check the level of signals being input to the INPUT jack by selecting .

Selecting  allows you to check the level of signals output from the GT-10.

Grouping Patches by Category (CATEGORY)

You can assign categories to patches and group them accordingly.

1.  Select the patch you want to include in a category.

2.  The MST/PDL FX screen appears.

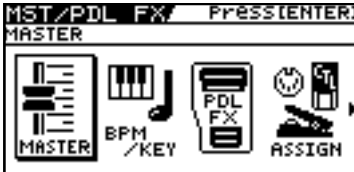

3.  Select NAME.



4.  The PATCH NAME screen appears.

5.  Select a category.

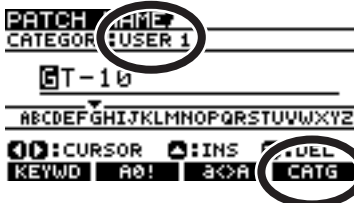







MEMO

- If you want to name the patch or edit the name, proceed to “Naming a Patch (PATCH NAME)” (p. 41) before you save.
- If you want to save a name of the patch with the settings you’ve made, proceed to “Saving a Patch (PATCH WRITE)” (p. 42).

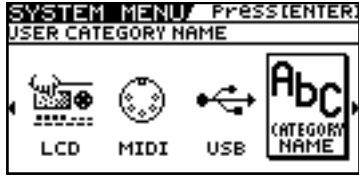







Naming User Categories (CATEGORY NAME)

The CATEGORY function also features ten user categories (USER1–10) you can name however you like.

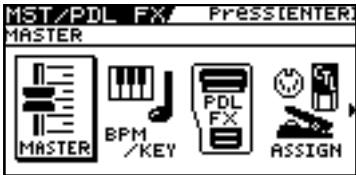





<p>1. </p>	<p>The SYSTEM MENU screen appears.</p> 	
<p>2. </p>	<p>Select CATEGORY NAME.</p> 	
<p>3. </p>	<p>The CATEGORY NAME screen appears.</p> 	
<p>4. </p>	<p>Select the name of the category you want to edit.</p>	
<p>5.</p>	<p>Use the same procedure as in “Naming a Patch (PATCH NAME)” (p. 41) to edit the name of the category.</p>	
<p>6.  twice.</p>	<p>The Play screen appears.</p>	<p>MEMO Category names are system parameters. They are saved at the time they are entered, and don't require the Write procedure.</p>

Naming a Patch (PATCH NAME)

Each patch can be given a name (PATCH NAME) consisting of up to sixteen characters. You'll probably want to take advantage of this feature by assigning names that suggest the sound you'll obtain, or the song in which it'll be used.

1.  Select the patch whose name you want to edit.
2.  The MST/PDL FX screen appears. 
3.  Select NAME. 
4.  The PATCH NAME screen appears. 
5.  Move the cursor to the position at which you want to change a character.
6.  Select the character.

You can use the following convenient operations.

Operation	Description	Operation	Description
	Inserts a blank space at the cursor position.		Deletes the character and shifts the characters that follow to the left.
	Inserts a keyword associated with the patch at the cursor position.		Switches between letters, numerals, and symbols.
	Switches between uppercase and lowercase letters.		Sets the category for the current patch. Refer to "Grouping Patches by Category (CATEGORY)" (p. 39)

MEMO

If you want to save a name of the patch with the settings you've made, proceed to "Saving a Patch (PATCH WRITE)" (p. 42).

7. If you want to edit names further, repeat Steps 5 and 6.

Chapter 3 Saving a Tone



Saving a Patch (PATCH WRITE)

If you want to save the changes in the settings, carry out the Write procedure.

NOTE

The patch previously stored at the write destination will be lost once the write is executed.

1.  The PATCH WRITE screen appears.

2.  Select the write-destination User patch.

3.  The GT-10 saves the changes in the settings to the write-destination patch.

MEMO

When no edits have been made to the currently selected patch, the PATCH COPY screen is displayed.

MEMO

To cancel the Write procedure, press [EXIT]. The Play screen returns to the display.

TIP

You can also use the procedure described in "Using the Pedal to Select the Patch" (p. 30) to select the write-destination.

MEMO

If you want to name the patch or edit the name, proceed to "Naming a Patch (PATCH NAME)" (p. 41) before you save.

Copying Patches (PATCH COPY)



You can copy a Preset or User patch to another User patch.

NOTE

The patch previously stored at the write destination will be lost once the write is executed.

1.  Select the patch you wish to copy.

2.  The PATCH COPY screen appears.

3.  Select the copy-destination User patch.

4.  The GT-10 copies the patch selected in Step 1 to the copy-destination patch.

cf.

"Selecting a Tone (Patch Change)" (p. 29)

MEMO

When edits have been made to the currently selected patch, the PATCH WRITE screen is displayed.

MEMO







To cancel the Write procedure, press [EXIT]. The Play screen returns to the display.

TIP

You can also use the procedure described in "Using the Pedal to Select the Patch" (p. 30) to select the copy destination.

Exchanging Patches (PATCH EXCHANGE)

On the GT-10, you can “swap” or exchange the positions of two User patches. The following explains how this is done.





1.		Select the exchange source patch.	<p>cf.</p> <p>“Selecting a Tone (Patch Change)” (p. 29)</p>
2.		The PATCH COPY screen appears.	<p>MEMO</p> <p>When edits have been made to the currently selected patch, the PATCH WRITE screen is displayed.</p>
3.		<p>Select the PATCH EXCHANGE (page 2) screen.</p> 	
4.		Select the exchange destination User patch.	<p>MEMO</p> <p>To cancel the Write procedure, press [EXIT]. The Play screen returns to the display.</p> <p>TIP</p> <p>You can also use the procedure described in “Using the Pedal to Select the Patch” (p. 30) to select the exchange destination.</p>
5.		The GT-10 exchange the positions of the two User patches.	

Initializing Patches (PATCH INITIALIZE)

You can return (initialize) a User patch to its original factory settings. This is convenient when you want to create a new patch from scratch.

NOTE

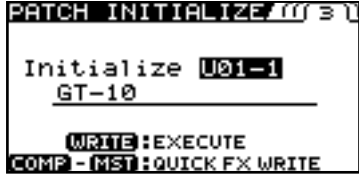
Any tone settings you've stored in a patch are lost once the initialization is executed.

1.		The PATCH COPY screen appears.	<p>MEMO</p> <p>When edits have been made to the currently selected patch, the PATCH WRITE screen is displayed.</p>
2.		<p>Select the PATCH INITIALIZE (page 3) screen.</p> 	
3.		Select the User patch you want to initialize.	<p>MEMO</p> <p>To cancel the Initialize procedure, press [EXIT]. The Play screen returns to the display.</p> <p>TIP</p> <p>You can also use the procedure described in “Using the Pedal to Select the Patch” (p. 30) to select the initialize destination.</p>
4.		The selected patch is initialized.	

Storing Settings by Effect (User Quick Settings)

In addition to storing settings in the form of patches, you can also store settings for individual effects.

Since you can use such stored settings in other patches, just like with the Preset Quick Settings (p. 35), storing effects settings you like ahead of time User Quick Settings is a convenient way to create new patches.

Effects That Can Be Stored			
PREAMP for each channels	CHORUS	EQ	FX-1/FX-2 Effects
OD/DS	REVERB	PEDAL FX WAH and Pedal Bend	ASSIGN1-8
DELAY	COMP	SEND/RETURN	

1. **WRITE**  The PATCH COPY screen appears.

Select the effect settings you want to save.



2. **EFFECTS SELECT**  The screen for specifying the destination to which to save the settings appears.

MEMO

- To save ASSIGN 1-8 settings (p. 50), set the SOURCE parameter to ASSIGN 1-8.
- When PREAMP is the source, the settings in the currently selected channel set by Channel Select (p. 98) will be saved. For FX-1/FX-2, the settings in the currently chosen effects set by FX1/FX2 (p. 102) will be saved.
- The PREAMP channels change with each press of [PREAMP].
- The effects shown below change with each press of [MASTER/PEDAL FX].
 - PEDAL WAH
 - PEDAL BEND
 - SEND/RETURN
 - ASSIGN 1-8

3.  Select the save-destination for the settings.

MEMO

When you want to change the User Quick Setting name (12 characters), press [DISPLAY MODE]. For information on how to enter characters, refer to steps 4 through 6 of "Naming a Patch (PATCH NAME)" (p. 41).

4. **WRITE**  The settings are saved.

Copying or Swapping PREAMP Settings Between Channels

You can take the PREAMP settings for a particular channel and copy them to another channel, or swap the settings for the two channels.

1. **WRITE**  The PATCH COPY screen appears.

The CH A/B UTILITY screen appears.

2. **CHANNEL SELECT**  A ○ B ●

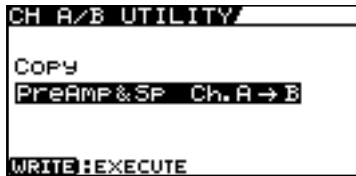

3.  Choose the copy or swap feature.









Display	Explanation
PreAmp&Sp Ch.A→B	This copies the channel A PREAMP and SPEAKER settings to channel B.
PreAmp&Sp Ch.B→A	This copies the channel B PREAMP and SPEAKER settings to channel A.
PreAmp&Sp Ch.A↔B	This swaps the channel A PREAMP and SPEAKER settings with the channel B settings.
Chain Ch.A↔B	This swaps the channel A PREAMP and SPEAKER settings with the channel B settings and also swaps the arrangement of channel A and channel B in the FX Chain.

4. **WRITE**  The selected function is executed.

Chapter 4 Playing Sounds

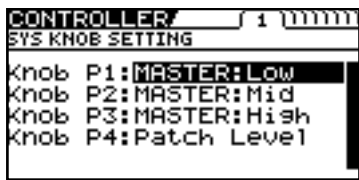
Setting the Functions of the Knobs of the Play Screen









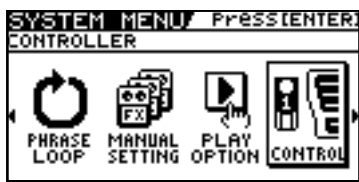

You can change the functions of the PARAMETER knobs.

1.		The SYSTEM MENU screen appears.	
2.		Select CONTROL. 	
3.		The CONTROLLER screen appears.	
4.		Select the SYS KNOB SETTING screen (page 1). 	
5.		Select the parameter knob (Knob P1–P4) whose assignment you want to change.	
6.		Change the parameter settings.	cf.  For information on what settings you can assign, refer to “Display of Parameters You Can Set with SYS KNOB SETTING” (p. 138).
7.	To change another controller setting, repeat Steps 5–6.		
8.	 twice.	The Play screen appears.	MEMO CONTROLLER parameters are system parameters. They are saved at the time they are entered, and do not require a Write procedure.

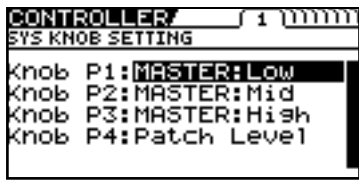
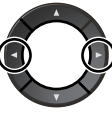
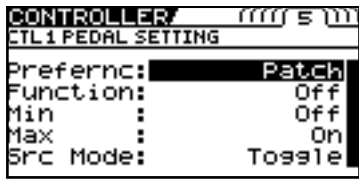
Using Pedals to Control the Parameters

Using the CTL/EXP Pedal With the Same Functions Assigned at All Times (Pedal Function)

This applies the functions of the CTL pedal, EXP Pedal and EXP PEDAL SW globally to the GT-10.

1.		The SYSTEM MENU screen appears.	
2.		Select CONTROL. 	
3.		The CONTROLLER screen appears. 	
4.		Select the controller whose assignment you want to change. 	
5.		Select Prefernc.	
6.		Set the Prefernc parameter to System.	
7.		Select the parameter of the chosen controller whose settings you want to change.	
8.		Change the parameter settings.	<p>cf. →</p> <p>For information on what settings you can assign, refer to "Function" (p. 138).</p>
9.		To change another controller setting, repeat Steps 4–6.	
10.	 twice.	The Play screen appears.	<p>MEMO</p> <p>CONTROLLER parameters are system parameters. They are saved at the time they are entered, and do not require a Write procedure.</p>

TIP

Example of Setting the Pedal Function

Setting the parameters as shown below in the EXP1 PEDAL SETTING screen enables you to constantly use the GT-10's EXP Pedal as a wah pedal.

Prefernc:	System
Function:	WAH
Min:	0
Max:	100

Setting CTL/EXP Functions Individually in Each Patch (Pedal FX)

This procedure sets the functions for the GT-10's controllers (CTL/EXP Pedal, EXP PEDAL SW) for individual patches.

* Set the Prefernc parameter of the CTL/EXP Pedal and EXP PEDAL SW (p. 137) settings to "Patch."

1.  The MST/PDL FX screen appears.

2. Select PEDAL/FX.

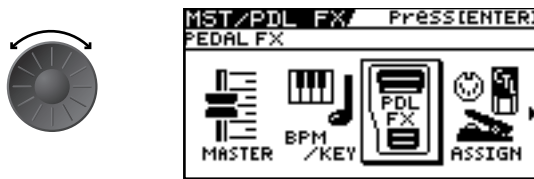

3. The PDL:CTL/EXP screen appears.

3. 



MEMO

Pressing [DISPLAY MODE] toggles the display between Knob View and List View.

4.  Make the parameter settings.

- P1: CTL1 Pedal
- P2: CTL2 Pedal
- P3: EXP PEDAL SW
- P4: EXP Pedal

MEMO

- Some EXP Pedal parameters use multiple pages for the parameter settings. You can use [◀] and [▶] to switch pages.
- Each time [MASTER/PEDAL FX] is pressed, the EXP Pedal functions alternate as shown below.

Parameter	Functions Switched
FV	Foot Volume On/Off
PB	Pedal Bend On/Off
WAH	Wah On/Off
PB/FV	Pedal Bend, Foot Volume
WAH/FV	Wah, Foot Volume

The currently selected setting is the one highlighted at the lower right of the display.

cf.

For information on what settings you can assign, refer to "SW&PDL FUNCTION" (p. 122).

5. To save the settings, use the Write procedure (p. 42).

TIP



EXP Pedal Function Quick Settings

You can select the Quick Settings by assigning either WAV/FV, PB/FV, WAH, or PB as the EXP Pedal Function. Selecting these prepared sample settings (Quick Settings) lets you choose optimal values for the related parameters instantly. This allows you to complete the settings simply and easily without the need to set each parameter individually.

1. Follow the procedure in "Setting CTL/EXP Functions Individually in Each Patch (Pedal FX)" (p. 48) step 1–3 to display the PDL:CTL/EXP screen.

2.  Select either WAV/FV, PB/FV, WAH, or PB.
The CONTROLLER EXP1 PEDAL SETTING screen (Page 2) appears.



3.   Select the Quick Setting (P01–P08, U01–U10).

cf.

For information on what settings you can assign, refer to "SW&PDL FUNCTION" (p. 122).

Display	Explanation
Quick:U**	User Quick Settings
Quick:P**	Preset Quick Settings
U01-1–U50-4	User Patch
P01-1–P50-4	Preset Patch

MEMO

When you select a User patch or Preset patch, you can use the existing patch's assign settings just as they are.

5. To save the settings, use the Write procedure (p. 42).

MEMO

When SYSTEM or CONTROLLER Messages Are Displayed

These appear when the Prefernc parameter for the Controller whose settings you attempted to change (CONTROLLER screen (p. 137)) is set to System.

This means that the settings in the SW&PDF FUNCTION screen, which are the patch parameters, have no effect.

To enable the settings in the SW&PDF FUNCTION screen, set the Prefernc parameter to Patch beforehand.



To dismiss this message, press [EXIT].

Setting Each Controller Functions to Individual Patches (Assign)









You can set the CTL/EXP Pedal, EXP PEDAL SW, and external controllers (footswitch and expression pedal) connected to the rear panel's EXP PEDAL 2/CTL 3,4 jacks for each individual patch.

You can save up to eight separate settings per patch (using Assign numbers 1 through 8) that determine what parameters are controlled by which controllers.

* Set the Prefernc parameter of the CTL/EXP Pedal and EXP PEDAL SW (p. 137) settings to "Patch."

Quick Settings

When you select prepared settings (Quick Settings), the relevant parameters are instantly set to their optimal values. This lets you make the settings simply, instead of setting each individual parameter separately.

- | | | | |
|----|---|--|--|
| 1. |  | The MST/PDL FX screen appears. | |
| 2. |  | Select ASSIGN. |  |
| 3. |  | The ASSIGN screen appears. |  |
| 4. |  | Select one of the ASSIGN number (No.1-8). | |
| 5. |  | Set the selected Assign number to "On." | MEMO
Each time [MASTER/PEDAL FX] is pressed it alternately switches the selected ASSIGN number on and off. When on, the Assign number at the bottom left of the display and the "ON" indication at the bottom right are highlighted. Be sure to set any Assign settings not being used to "Off." |
| 6. |  | Select the Quick Setting (P01-P08, U01-U10). | |

Display	Explanation
Quick:U**	User Quick Settings
Quick:P**	Preset Quick Settings
U01-1.1-U50-4.8	User Patch
P01-1.1-P50-4.8	Preset Patch









MEMO
When you select a User patch or Preset patch, you can use the existing patch's assign settings just as they are.

7. To use the Quick Settings with other Assigns, repeat Steps 4-6.

8. To save the settings, use the Write procedure (p. 42).

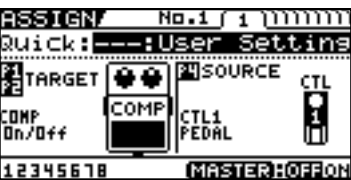
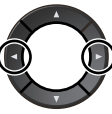
Manual Settings

Here, you can individually determine which controller is to control which parameter.

1.		The MST/PDL FX screen appears.	
2.		Select ASSIGN. 	
3.		The ASSIGN screen appears. 	
4.		Select one of the ASSIGN number (No.1–8).	
5.		Set the selected Assign number to “On.”	<p>MEMO</p> <p>Each time [MASTER/PEDAL FX] is pressed it alternately switches the selected ASSIGN number on and off. When on, the Assign number at the bottom left of the display and the “On” indication at the bottom right are highlighted. Be sure to set any Assign settings not being used to “Off.”</p>
6.		Select the controller that you want to edit the parameter.	
7.		Select the parameter you wish to control.	<p>TIP</p> <p>You can rapidly select the parameter you want by using the P1 knob to navigate down from the broad category.</p>
8.	To set the other Assigns, repeat Steps 4–7.		<p>MEMO</p> <p>Only the TARGET and the SOURCE are shown in Icon View. If you want to have all parameters appear, switch to List View.</p>
9.	To save the settings, use the Write procedure (p. 42).		

About the Range of a Target's Change

The value of the parameter selected as the target changes within the range defined by "Min" and "Max," as set on the GT-10. When using an external footswitch, or other controller that acts as an on/off switch, "Min" is selected with Off (CLOSED), and "Max" is selected with On (OPEN).

When using an external expression pedal or other controller that generates a consecutive change in the value, the value of the setting changes accordingly, within the range set by the minimum and maximum values. Also, when the target is of an on/off type, the median value of the received data is used as the dividing line in determining whether to switch it on or off.

When using the footswitch:

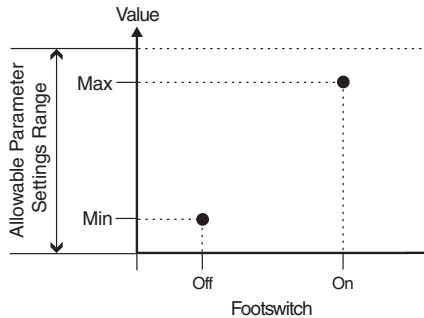

When controlling the On/Off target with the EXP Pedal:

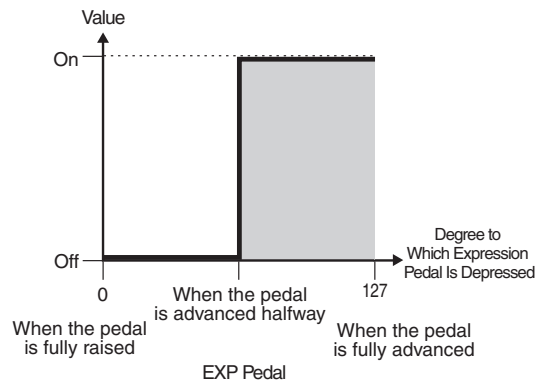

When using the EXP Pedal:

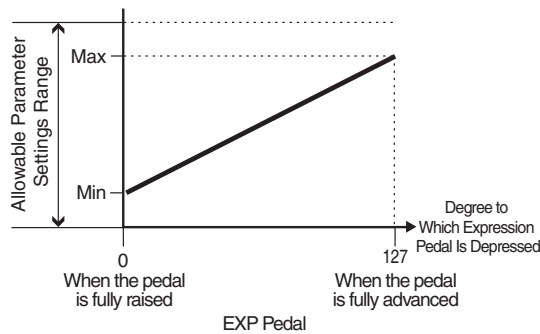

- * The range that can be selected changes according to the target setting.
- * When the "minimum" is set to a higher value than the "maximum," the change in the parameter is reversed.
- * The values of settings can change if the target is changed after the "minimum" and "maximum" settings have been made. If you've changed the target, be sure to recheck the "minimum" and "maximum" settings.

About the Range of a Controller's Change

This sets the operational range within which the value of the setting changes when an EXP Pedal or other controller that changes the value consecutively is used as the source. If the controller is moved outside the operational range, the value does not change, it stops at "minimum" or "maximum."

(Example) With ActRngLo: 40, ActRngHi: 80

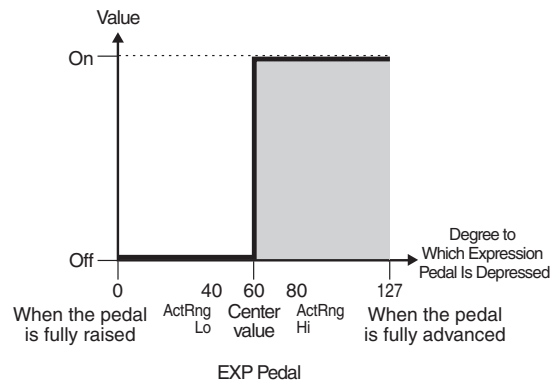
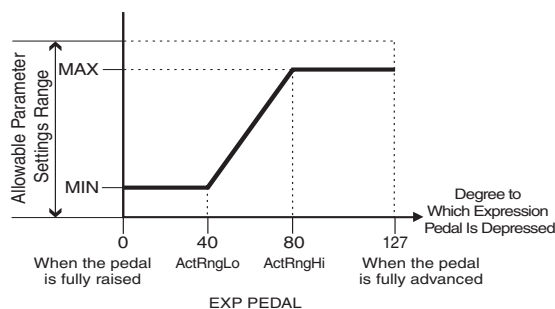

- * When using a footswitch or other on/off switching controller as the source, leave these at "ActRngLo: 0" and "ActRngHi: 127." With certain settings, the value may not change.

TIP

Example of Assign Settings

Setting the parameters as shown below enables you to use the GT-10's EXP Pedal as a UNI-V rate parameter.

Target:	FX1:UV:Rate	Src Mode:	Moment
Min:	0	ActRngLo:	0
Max:	100	ActRngHi:	127
Source:	EXP1 PEDAL		

Activating the Virtual Expression Pedal at the Start of Operations (Internal Pedal System)

The GT-10 features a function called Internal Pedal system. This function assigns specified parameters to a virtual expression pedal (the internal pedal), providing an effect that automatically changes volume and tone in real time just the way an expression pedal functions.

The Internal Pedal system features the following two functions, allowing you to set Source for each ASSIGN No.1-8 of the "Manual Settings" (p. 51).

* When the Internal Pedal or the Wave Pedal is used, set the ASSIGN Src Mode to Moment.

Internal Pedal

With the trigger you have set, the assumed expression pedal starts working. If you have set INTERNAL PDL to Source, set the Int Trig parameter.

cf.

For more detailed information on the parameters that can be set using Internal Pedal, refer to "Int Trig (Internal Pedal Trigger)" (p. 126), "Int Time (Internal Pedal Time)" (p. 126), and "IntCurve (Internal Pedal Curve)" (p. 126).

Wave Pedal

This changes the parameter selected as a target in a certain cycle with the assumed expression pedal. When you have set Wave Pedal for Source, the WaveRate and Waveform should be set.

cf.

For more detailed information on the parameters that can be set using Wave Pedal, refer to "WaveRate (Wave Pedal Rate)" (p. 126) and "Waveform (Wave Pedal Form)" (p. 127).

Turning the Effects On and Off with the BANK/Number Pedals (Manual Mode)

The GT-10 features a Manual mode, in which the pedals are used for switching specified effects on and off. In Manual mode, you can switch effects on and off without changing the patch number.

Switching to Manual Mode

1. Press this button several times until the following screen appears.



Manual mode is enabled when this screen is displayed.

MEMO

- You can press [CATEGORY/ENTER] in this screen to switch to the MANUAL SETTING screen (p. 56).
- Setting the TARGET to Manual Mode Sw in “Manual Settings” (p. 51) enables you to switch Manual mode on and off.

2. Switching away from the MANUAL MODE screen turns off Manual mode.

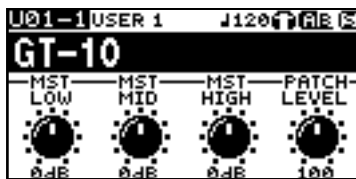

Switching Effects On and Off with the Pedals

1. Perform “Switching to Manual Mode” (p. 55), to turn Manual mode on.

2.  etc.

The pedal switches the assigned effect on or off.

MEMO

The assigned effect is switched on or off with each press of the pedal. When the assigned effect is on, the indicator at the top of the pedal lights up.

Assigning an Effect On/Off Switch to a Pedal

1.  The SYSTEM MENU screen appears.

MEMO

You can also enter the MANUAL SETTING screen from the Play screen (p. 55).

2.  Select MANUAL SETTING.



3.  The MANUAL SETTING screen appears.



4.  Select the pedal whose assignment you want to change.

5.  Select the effect switch you want to assign to the pedal.

6. To change another pedal setting, repeat Steps 4–5.

Assignable Effect Switches

Display	Explanation
Off	The function is not assign to the pedals.
Ch.A/B	Switches between Preamp channel A and B.
OD Sol	Switches OD/DS SOLO on and off.
Solo	Switches Preamp SOLO on and off.
A&BSol	Switches the preamp SOLO, for both channel A and B, on and off. If one of the two channels is off, both will be turned on.
Comp	Switches the COMP on and off.
OD/DS	Switches the OD/DS on and off.
Preamp	Switches the PREAMP/SPEAKER on and off.
EQ	Switches the EQ on and off.
FX1	Switches FX-1 on and off.
FX2	Switches FX-2 on and off.
Delay	Switches the DELAY on and off.
Chorus	Switches the CHORUS on and off.
Reverb	Switches the REVERB on and off.
PdIFX	Switches the Pedal FX on and off.
S/R	Switches the SEND/RETURN on and off.
AmpCTL	Switches the Amp Control on and off.
Tuner	Switches the TUNER/BYPASS on and off.

Display	Explanation
PL	Switches the PHRASE LOOP on and off.
PL R/P	Records/plays back the phrase.
PL Clr	Clears the phrase.
PL M/P	Mutes playback of the phrase.
BPM Tap	Used for tap input of the Master BPM.
Dly Tap	Used for tap input of the delay time.
MIDI	Controls the Start/Stop of external MIDI devices (such as sequencers).
MMCPly	Controls the Play/Stop of external MIDI devices (such as hard disk recorders).
Lev+10	Increases the patch volume level by 10 units.
Lev+20	Increases the patch volume level by 20 units.
Lev -10	Decreases the patch volume level by 10 units.
Lev -20	Decreases the patch volume level by 20 units.
NumInc	Switches to the next higher patch number in the same bank as the currently selected patch.
NumDec	Switches to the next lower patch number in the same bank as the currently selected patch.
BankInc	Switches to the next higher bank number.
BankDec	Switches to the next lower bank number.

Switching Settings with the Number Pedals



The GT-10 includes a function that allows you to turn the tuner on and off, switch preamp channels, and perform other tasks by pressing the pedal with the same number as the currently selected patch.

MEMO

You can switch the following functions in any condition other than the Manual Mode.

1.  The SYSTEM MENU screen appears.

Select PLAY OPTION.

2.  

3.  The PLAY OPTION screen appears.

Select Num Pdl Sw.

4.  

5.  Set the Num Pdl Sw Parameter.

Display	Explanation
Off	Not used.
Tuner	Switches the tuner on and off.
Ch. A/B	Switches between preamp channels A and B.
OD Solo	Switches to tones suited to solo performance.
Solo	Switches the preamp SOLO on and off.
AB Solo	Switches SOLO on or off for both preamp channels A and B.

Phrase Loop Play



What's Phrase Loop?

In this mode, you can record up to 38 seconds of material (recorded in mono) and repeatedly play material as a “phrase loop.” As the loop plays, you can overdub new material if desired.

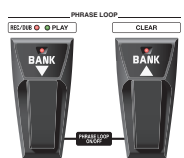

You can record a phrase loop with effects, or you can add effects after a loop has been recorded. Adding effects after-the-fact lets you create special effects with recorded performances. It's also a great way to audition tones, as you can adjust effect parameters in real time while a phrase plays back.

Using the Phrase Loop

Recording a Phrase (REC)

<p>1. </p>	<p>Press [BANK▼] and [BANK▲] at the same time. The unit goes into recording standby (The REC/DUB indicator flashes).</p>	<p>MEMO Simultaneously pressing these a second time stops loop playback and switches Phrase Loop off.</p>
<p>2. </p>	<p>Recording starts. (The REC/DUB indicator lights up.) Play the phrase you want to record.</p>	<p>MEMO The maximum recording time for monaural recording is approximately 38 seconds. When the recording time reaches 38 seconds, playback of the recorded performance starts automatically.</p>
<p>3. </p>	<p>Recording stops. (The REC/DUB indicator goes out.) The recorded phrase is looped (played repeatedly). (The PLAY indicator lights up.)</p>	

Overdubbing Sound onto a Phrase (DUB)



<p>1. Follow the procedure in “Recording a Phrase (REC)” (p. 58) to record a phrase, then perform loop play. (The PLAY indicator lights up.)</p>	
<p>2. </p>	<p>TERM Recording on top of an existing performance is called “overdubbing.”</p>
<p>3. </p>	<p>MEMO If you want to overdub additional material, repeat steps 2 and 3.</p>

Deleting a Phrase (CLEAR)

The procedure for deleting a phrase differs according to the setting of the Clear Pd1 parameter.







cf.

For information on the Clear Pd1 parameter, refer to “Clear Pd1 (Clear Pedal Function)” (p. 60).

When the Clear Pd1 parameter is “Clear Only”		When the Clear Pd1 parameter is “Mute/Clear”	
1. 	The phrase is deleted and the unit goes into recording standby.	1. 	Pressing this during recording stops recording and puts the unit in muted playback. (The PLAY indicator flashes.) No sound is produced, but loop play continues inside the GT-10. Pressing [BANK ▼] while the unit is muted enables normal loop playback. (The PLAY indicator lights up.)
		2. 	Pressing this while the sound is muted deletes the phrase and puts the unit in recording standby.

Setting Phrase Loop

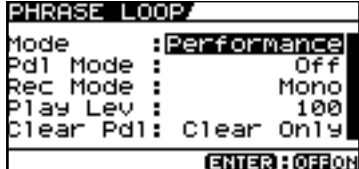
You can also enable different uses by changing the parameters.

1. 	The SYSTEM MENU screen appears.	
2. 	Select PHRASE LOOP.	
3. 	The PHRASE LOOP screen appears.	
4. 	Move the cursor to select the parameter you wish to change.	
5. 	Change the parameter settings.	

Parameter/Range	Explanation
Mode	
Performance	This records the sound after it passes through the effects. This lets you achieve a rich variety of performances by combining different tones.
Patch Edit	This records the sound before it passes through the effects, and applies the effects during loop play. This enables you to adjust effects or compare patch tones.

Chapter 4 Playing Sounds

Parameter/Range	Explanation
Pdl Mode (Pedal Mode)	
Off	The BANK pedals are not used for operation of the Phrase Loop feature. These are used as bank switch pedals. TIP Phrase Loop can be controlled by assigning the Phrase Loop feature to any of the CTL pedals 1 through 4 and maintaining the BANK pedals' bank switching function.
On	The BANK pedals are used for operation of the Phrase Loop feature.
Rec Mode (Recording Mode)	
Mono	Phrases are recorded in mono (max. 38 seconds).
Stereo	Phrases are recorded in stereo (max. 19 seconds).
Play Lev (Play Level)	
0-120	Sets the phrase playback volume.
Clear Pdl (Clear Pedal Function)	
Clear Only	When you press [BANK ▲] while the Phrase Loop feature is on, the recorded data is cleared and then GT-10 switches to STANDBY mode.
Mute/Clear	When you press [BANK ▲] while the Phrase Loop feature is on, the performance of the recorded phrase is muted (the recorded data is not erased). If you then press [BANK ▲] again while the phrase is muted, the recorded data is cleared and then GT-10 switches to STANDBY mode.

Overview of Phrase Loop Operation

When the PHRASE LOOP function and the Pdl Mode parameter are both set to "on," phrase loop operation is switched as shown below.

When the Clear Pdl parameter is "Clear Only"

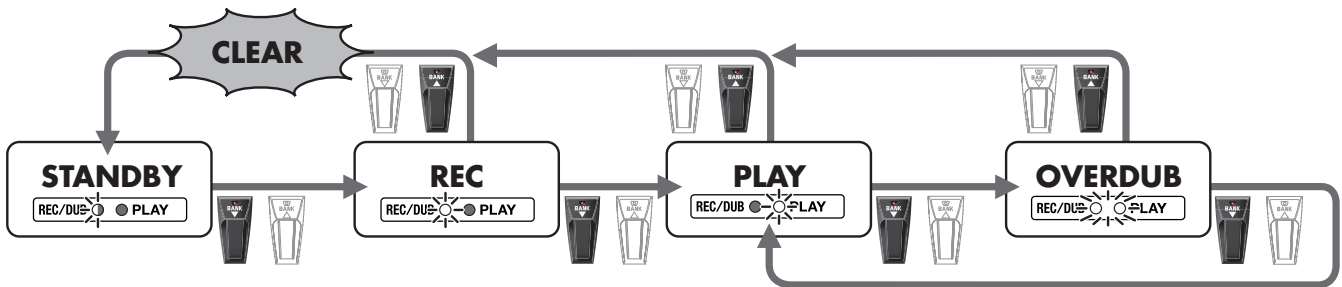

When the Clear Pdl parameter is "Mute/Clear"

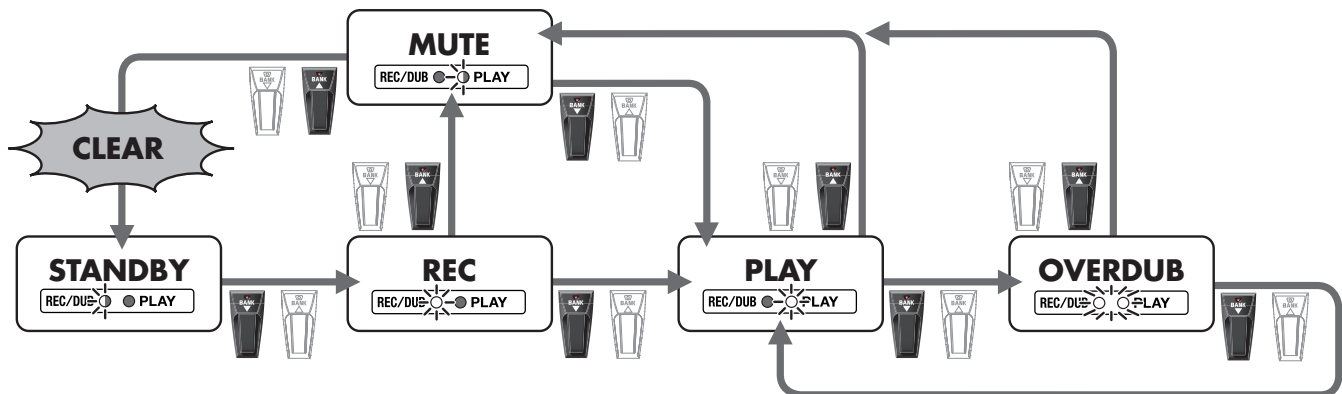







Chapter 5 Making Global Settings

Making Settings Matched to the Connected Guitar (Input Select)

The GT-10 includes a feature for adjusting the tone to suit whatever guitar you have connected, allowing you to make settings for three guitar types (Guitar 1–3). This is effective when you are connecting a different guitar from the one used when the patch was created.

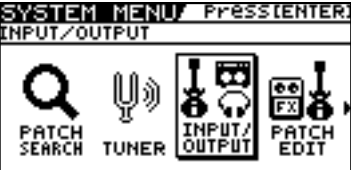
NOTE

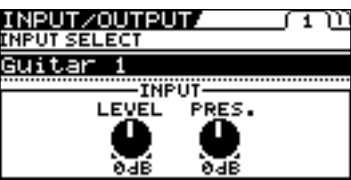
When adjusting the input level and input presence, the input signals for all patches are affected. Note that the nuances of the effect sounds that occur in response to guitar volume may change, particularly with patches in which effects are controlled by the guitar volume.

1.		The SYSTEM MENU screen appears.	
2.		Select INPUT/OUTPUT. 	
3.		The INPUT/OUTPUT screen appears. 	
4.		Select the INPUT SELECT (Guitar 1–3) you want to set.	MEMO Select USB In when you're inputting audio from a computer via USB (p. 134).
5.		P2 knob: Adjusts the guitar input level. P3 knob: Adjusts the tonal quality of the guitar's high end.	cf. For information on the parameters, refer to "INPUT" (p. 134).

Adjusting the Overall Sound to Match the Usage Environment (Global)

The GT-10 includes a feature that allows you to change the overall tone of all patches. This is called the “Global function.” With the Global function, you can change your settings to match those of your equipment and the operating environment, while leaving the settings in the patches untouched.

Adjusting the Overall Tone (Global EQ)

This adjusts the tone of the OUTPUT regardless of the equalizer on/off settings of individual patches.

1.  The SYSTEM MENU screen appears.

2. Select INPUT/OUTPUT.

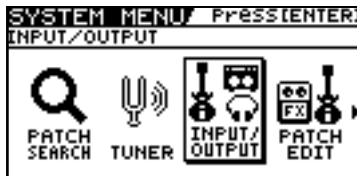

3.  The INPUT/OUTPUT screen appears.

4. Select the GLOBAL EQ (page 2) screen.

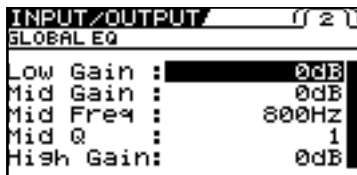
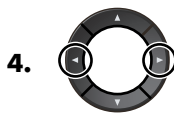

5.  Move the cursor to the parameter you want to set.

6.  Adjust the parameter.

cf.

For information on the parameters, refer to “GLOBAL EQ” (p. 134).

Parameter	Explanation
Low Gain	Adjusts the low frequency range tone.
Mid Gain (Middle Gain)	Adjusts the middle frequency range tone.
Mid Freq (Middle Frequency)	Specifies the center of the frequency range that will be adjusted by the MID GAIN.
Mid Q (Middle Q)	Adjusts the width of the area affected by the EQ centered at the MID FREQ. Higher values will narrow the area.
High Gain	Adjusts the high frequency range tone.

Controlling the Overall Effect of the Noise Suppressor (Total Noise Suppressor)

This controls the overall threshold value for the noise suppressor settings in the individual patches. This is an effective tool when guitars are changed during performances and for making adjustments in response to noise levels at the performance venue.

This is an overall setting and does not alter the individual patch settings.

MEMO

This has no effect on patches in which the noise suppressor is turned off.

1.  The SYSTEM MENU screen appears.

Select INPUT/OUTPUT.

2.  

3.  The INPUT/OUTPUT screen appears.

Select the TOTAL (page 3) screen.

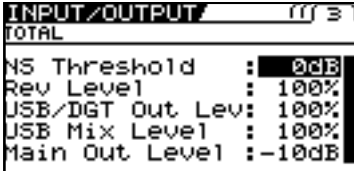
4.  

5.  Move the cursor to NS Threshold.

6.  Adjust the threshold level of the Noise Suppressor.

MEMO

Set to "0 dB" when using this in individual patch settings.

cf.

For information on the parameters, refer to "NS Threshold (Noise Suppressor Threshold)" (p. 135).

Controlling the Overall Reverb Level (Total REVERB)

This controls the overall reverb level settings in the individual patches. This is effective for adjusting to the acoustics of the performance venue.

This setting does not affect the individual patch settings.

MEMO

This has no effect on patches in which the reverb is turned off.

1.  The SYSTEM MENU screen appears.

Select INPUT/OUTPUT.

2.  

3.  The INPUT/OUTPUT screen appears.

Select the TOTAL (page 3) screen.

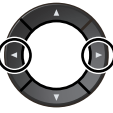
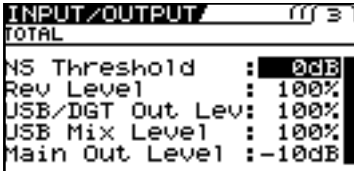
4.  

5.  Move the cursor to Rev Level.

6.  Adjust the reverb level.

MEMO

Set to "100%" when using this in individual patch settings.

cf.

For information on the parameters, refer to "Rev Level (Reverb Level)" (p. 135).

Setting the Output Reference Level to Match the Connected Equipment (Main Out Level)

This sets the output reference level to match the equipment connected to the OUTPUT jack.

1.  The SYSTEM MENU screen appears.

Select INPUT/OUTPUT.

2.  

3.  The INPUT/OUTPUT screen appears.

Select the TOTAL (page 3) screen.

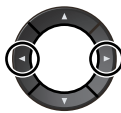
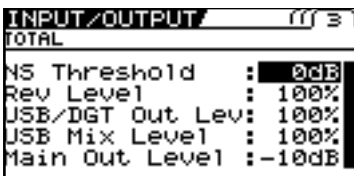
4.  

5.  Move the cursor to Main Out Level.

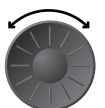
6.  Adjust the reference level.









Value	Explanation
-10dB	Choose this when connected to a guitar amp.
+4dB	Choose this when connected to a recorder, mixer, or other line device.

Adjusting the Output Level of the DIGITAL OUT Jack

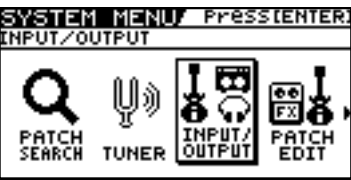
You can adjust the level of the audio signals output from the DIGITAL OUT jack.

Digital signals are output from the DIGITAL OUT jack on the rear panel. You can connect this directly to the digital in connector of a digital recorder or other device and record with no degradation in sound quality.

The same digital audio signals are output from DIGITAL OUT and USB.

1.		The SYSTEM MENU screen appears.	
2.		Select INPUT/OUTPUT. 	
3.		The INPUT/OUTPUT screen appears.	
4.		Select the TOTAL (page 3) screen. 	
5.		Move the cursor to USB/DGT Out Lev.	
6.		Adjust the level.	

Adjusting the Display Contrast (LCD Contrast)

Depending on where the GT-10 is placed, the display (on the right) may become difficult to read. If this occurs, adjust the display contrast.

1.  The SYSTEM MENU screen appears.

2.  Select LCD.

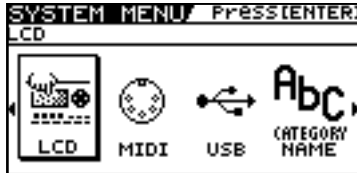

3.  The LCD screen appears.



4.  Adjust so that you can view the screen easily.

Keeping Effect Sounds Playing After Patches Are Switched (Patch Change Mode)



The GT-10 features a mode that is enabled when spatial effects (such as reverb and delay) are used, whereby the effects sound of one patch continues playing even after you switch to the next patch. If the necessary following conditions regarding the effects chain and effect parameter settings are met, you can then have the decay of reverb, delay, and similar effects continue on into the next patch after you switch patches.

- Effects are in the same effects chain
- When switching the delay off or on, or when the Type parameter and Dly Time parameter are identical
- When switching other effects off or on, or when the parameter settings are identical

MEMO

There still may be no reverberation in some cases, even after the above settings are made.

1.  The SYSTEM MENU screen appears.

2.  Select PLAY OPTION.

3.  The PLAY OPTION screen appears.

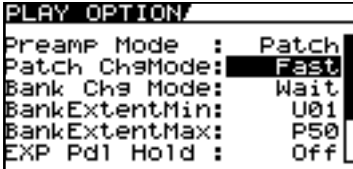
4.  Move the cursor to Patch ChgMode.

5.  Select the value of the Patch ChgMode parameter.







Value	Explanation
Fast	Patches are changed normally. The unit switches to the subsequent patch without any carry-over of the decay from the previous patch's reverb or delay.
Smooth	The unit switches to the subsequent patch with the decay from the previous patch's reverb or delay continued after the switch is made. <p>MEMO To ensure smooth switching, the patches may be switched with a delay of one tempo beat.</p>

Using the Identical Preamp Settings in All Patches (Preamp Mode)

With the GT-10, you can have a preamp be set globally for use in all patches, allowing you to make settings for three preamp types.

This provides an effect that always gives you the sound of the same guitar amp regardless of the patches you set.

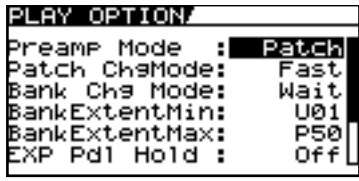
Using the System Preamp

1.  The SYSTEM MENU screen appears.
2.  Select PLAY OPTION.

3.  The PLAY OPTION screen appears.
4.  Move the cursor to Preamp Mode.

5.  Select the value of the Preamp Mode parameter you want to set.

Value	Explanation
Patch	The patch preamp setting is used. This allows you to use different preamp settings in each individual patch.
System1-3	The system's preamp setting is used. This applies the same preamp settings to all patches.

Setting the System Preamp

When Preamp Mode is System1 through System3, the changed preamp setting is saved as the system's preamp setting. The stored content is updated each time the settings are changed.

Saving the Current Preamp Setting As the System's Preamp Setting

You can save the current preamp setting as a preamp setting for the system (System1 through System3).

1. **WRITE**

The PATCH COPY screen appears.

MEMO

When edits have been made to the currently selected patch, the PATCH WRITE screen is displayed.

2. 

Select the SYS PREAMP WRITE screen.



3. 

Select the save-destination system preamp (System1-3).

MEMO

To cancel the Write procedure, press [EXIT]. The Play screen returns to the display.

4. **WRITE**

The settings are saved.

Limiting the Banks That Can Be Switched (Bank Extent)

By setting an limit to the range of banks that can be switched, you can set the GT-10 so that only the patches you need can be selected.

1.  The SYSTEM MENU screen appears.

Select PLAY OPTION.

2.  

3.  The PLAY OPTION screen appears.

Move the cursor to BankExtentMin.

4.  

5.  Set the lower limit for the banks.

6.  Move the cursor to BankExtentMax.

7.  Set the upper limit for the banks.

Setting the Timing Used for Switching Patches (Bank Change Mode)

This sets the timing with which the GT-10 switches to the next patch when switching banks with the pedals.

1.  The SYSTEM MENU screen appears.

Select PLAY OPTION.

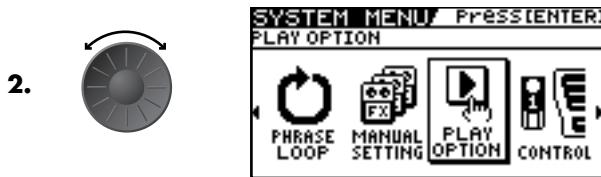

3.  The PLAY OPTION screen appears.

Move the cursor to Bank Chg Mode.

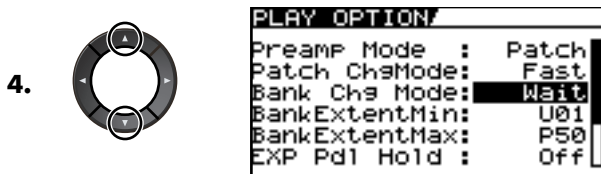

5.  Set the timing for switching patches.







Value	Explanation
Wait	Although the indication in the display is updated to reflect the change in the bank when a BANK pedal is pressed, the patch will not change. The patch changes when a number pedal is pressed.
Immed	The patch switches instantly when a BANK pedal or any of the number pedals is pressed.

Having Values from an EXP Pedal Carried Over When Patches are Called Up (EXP Pedal Hold)

This setting determines whether or not the EXP Pedal operational status is carried over to the next patch when patches are switched.

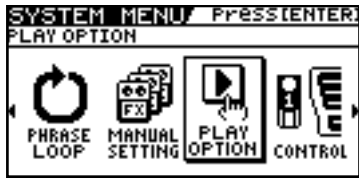
MEMO

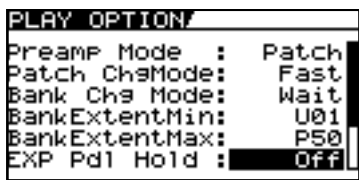
EXP Pedal Hold does not function if the Assign Source mode is set to Toggle (whereby the value is toggled between Min and Max each time the pedal is pressed).

1.  The SYSTEM MENU screen appears.
2.   Select PLAY OPTION.
3.  The PLAY OPTION screen appears.
4.   Move the cursor to EXP Pd1 Hold.
5.  Set whether EXP Pedal Hold is used or not.

Value	Explanation
Off	The EXP Pedal status is not carried over. (Example) If a patch is switched while the volume is being controlled with an EXP Pedal, the volume of the subsequent patch is adjust to the value set in that patch. If the EXP Pedal is operated, and that information is transmitted to the GT-10, the volume will change in accord with the pedal's movement.
On	The EXP Pedal status is carried over. (Example) If a patch is switched while the volume is being controlled with the EXP Pedal, the volume of the subsequent patch will take on the value determined by the current pedal position (angle). If the patch switched to has the EXP Pedal controlling the wah effect, then the volume assumes the value set in the patch, and the patch's wah effect is given the value derived from the current pedal position (angle).



Switching How the Pedal Indicators Light (Pedal Indicate)

You can have all unlit pedal indicators flash faintly instead.

This makes it easier to locate pedal positions on stage and in other darkened environments.

1.  The SYSTEM MENU screen appears.

Select PLAY OPTION.

2.  

3.  The PLAY OPTION screen appears.

Move the cursor to Pdl Indicate.

4.  

5.  Set whether Pedal Indicate function is used or not.



Value	Explanation
Off	The Pedal Indicator function is not use.
On	All unlit pedal indicators flash.

Selecting the Dial Function (Dial Function)

This setting determines whether or not rotating the dial switches the patches.

1.  The SYSTEM MENU screen appears.

Select PLAY OPTION.

2.  

3.  The PLAY OPTION screen appears.

Move the cursor to Dial Func.

4.  

5.  Select the dial function.

Value	Explanation
Pat&Val	The dial is used both for switching patches and changing the value of settings. In addition to switching patches with the pedals, you can also switch them by rotating the dial.
Value	The dial is used only for changing the values of settings.

Restoring the Factory Settings (Factory Reset)

Restoring the GT-10 to the settings made at the factory is referred to as a “Factory Reset.”

Not only can you return all of the settings to the values in effect when the GT-10 was shipped from the factory, you can also specify the range of settings to be reset.

1.  The SYSTEM MENU screen appears.



Select FACTORY RESET.

2.  

The FACTORY RESET screen appears.

3.  

Set the range for the Factory Reset (Refer to the following table).

4.  

The range of data you wish to factory reset











Value	Explanation
System	System parameter settings
Quick	Settings for User Quick Setting 1-10
U01-1-U50-4	Settings for Patch Number U01-1 through U50-4

5.  The specified range of parameters are returned to their original factory settings.

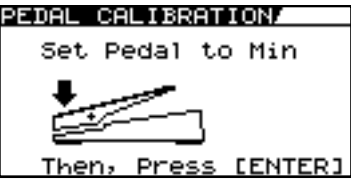
Adjusting the EXP Pedal

Although the GT-10's EXP Pedal has been set for optimum operation at the factory, extended use and the operating environment can result in the pedal going out of adjustment.

If you encounter problems such as being unable to fully cut off the sound with the volume pedal or being unable to switch the EXP PEDAL SW, you can use the following procedure to readjust the pedal.

1.		The SYSTEM MENU screen appears.	
2.		Select PDL CALIBRATION. 	
3.		The PEDAL CALIBRATION screen appears. 	
4.		Depress the heel of the EXP Pedal.	
5.		The message "OK" appears, and then the following screen is displayed. 	MEMO If you press [CATEGORY/ENTER] without pressing down on the heel of the EXP Pedal or with an inappropriate EXP Pedal value (angle), "Area Over" appears in the display, and you are prevented from proceeding to the next step. Readjust the pedal position.
6.		Depress the toe of the EXP Pedal.	
7.		The message "OK" appears, and then the following screen is displayed. 	MEMO If you press [CATEGORY/ENTER] without pressing down on the toe of the EXP Pedal or with an inappropriate EXP Pedal value (angle), "Area Over" appears in the display, and you are prevented from proceeding to the next step. Readjust the pedal position.

Chapter 5 Making Global Settings

8.



Firmly depress the toe of the EXP Pedal.

9.



Repeat steps 8 and 9 to adjust the Thres parameter so that the EXP PEDAL SW indicator lights up and goes out with appropriate depression force.

10.



The sensitivity of the PEDAL SW is calibrated.

Chapter 6 Using the GT-10 with External MIDI Devices Connected

What Can You Do with MIDI?

You can perform the following operations using MIDI with the GT-10.

MEMO

The use of MIDI requires that the MIDI channels of the connected devices match. If the MIDI channel settings are not correct, the GT-10 will be unable to exchange data with other MIDI devices.

Operating From the GT-10

Outputting Program Change Messages

When a patch is selected on the GT-10, a Program Change message corresponding to the patch number is transmitted simultaneously. The external MIDI device then switches its settings according to the Program Change message it receives.

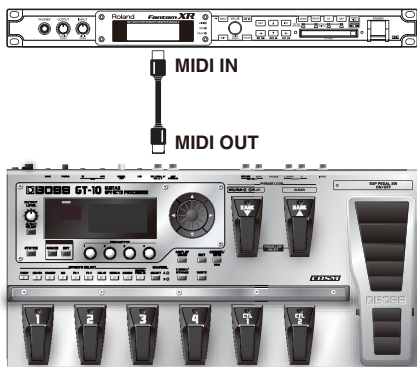

Outputting Control Change Messages

Data describing the actions of the CTL pedal, EXP Pedal, EXP PEDAL SW, and external devices connected to the EXP PEDAL 2/CTL 3, 4 jack are output as Control Change messages. Such messages can be used to (among other things) manipulate the parameters of an external MIDI device.

Transmitting Data

You can use Exclusive messages to transmit the settings for effect sounds and other content stored in the GT-10 to other MIDI devices. For example, you can provide another GT-10 with the same settings, and save effect sound settings to a sequencer or other device.

Remotely Controlling the GT-10 Using an External MIDI Device

Switching Patch Numbers

When the GT-10 receives Program Change messages from the external MIDI device, its patches are simultaneously switched.

MEMO

You can set up the correspondence between MIDI Program Change messages and the GT-10's patches using the Program Change Map (p. 84). You may need to work on these correspondences when you want to line up some effects in combination with other MIDI devices.

The connections shown in the figure below are for a sequencer automatically performing the backing as a guitar is being played. The patches are switched automatically when the program numbers corresponding to the patches are input along with the performance data at the points where you have determined the GT-10 patches are to be switched.

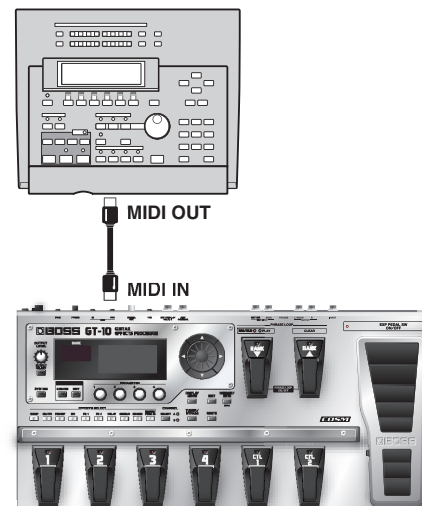

Receiving Control Change Messages

MEMO

You can control specified parameters during a performance by having the GT-10 receive Control Change messages. Parameters to be controlled are set with "Manual Settings" (p. 51).

Receiving Data

The GT-10 can receive data transmitted from another GT-10, as well as data that's been stored on a sequencer.









Exchanging MIDI Messages between the Computer and the GT-10

If you set the GT-10 into the specialized driver mode and connect it to your PC/Mac by a USB cable, you can transfer MIDI message bidirectionally via USB. Set your computer MIDI input and output ports to "GT-10."

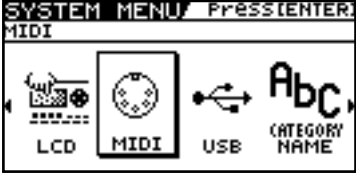
If you set USB connection between the GT-10 and PC/Mac, MIDI message transfer via MIDI connectors become inactivated.

Making the Settings for MIDI Functions

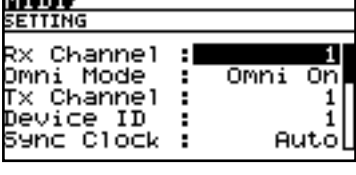
Here is a description of the GT-10's MIDI functions. Set them as needed, depending on the intended use.

1.		The SYSTEM MENU screen appears.	
2.		Select MIDI. 	
3.		The MIDI MENU screen appears.	
4.		Select SETTING. 	
5.		The SETTING screen appears. 	
6.		Select the parameter.	
7.		Change the setting's value.	<p>MEMO</p> <p>Set each parameter as necessary. For details on these settings, refer to the following sections.</p>

Setting the MIDI Receive Channel

This sets the MIDI channel used for receiving MIDI messages.

1. Follow the procedure in "Making the Settings for MIDI Functions" (p. 80) to move the cursor to "Rx Channel."
2. Set the desired value.



1-16

Setting the MIDI Omni Mode

This makes the settings for the channels used for MIDI information.

1. Follow the procedure in “Making the Settings for MIDI Functions” (p. 80) to move the cursor to “Omni Mode.”

2. Set the desired value.



Omni On	Messages are received on all channels, regardless of the MIDI channel settings.
Omni Off	Information is received on the channel specified by the Rx Channel setting.

MEMO

- Even when Omni Mode is set to “Omni On”, the only Exclusive messages received are for Device ID data set with “Device ID.”

Setting the MIDI Transmit Channel

This sets the MIDI channel used for transmitting MIDI messages.

1. Follow the procedure in “Making the Settings for MIDI Functions” (p. 80) to move the cursor to “Tx Channel.”

2. Set the desired value.



1-16, Rx

MEMO

- When set to “Rx,” this MIDI channel is same as the MIDI Receive channel.

Setting the MIDI Device ID

This sets the MIDI Device ID used for transmitting and receiving Exclusive messages.

1. Follow the procedure in “Making the Settings for MIDI Functions” (p. 80) to move the cursor to “Device ID.”

2. Set the desired value.



1-32

Setting the MIDI Sync Clock

This setting determines the basis used for synchronizing the timing for effect modulation rates and other time-based parameters.

1. Follow the procedure in “Making the Settings for MIDI Functions” (p. 80) to move the cursor to “Sync Clock.”

2. Set the desired value.



Auto	Operations are synchronized to the MIDI Clock received via MIDI. However, operations are automatically synchronized to the GT-10’s internal Clock if the GT-10 is unable to receive the external Clock.
Internal	Operations are synchronized to the GT-10’s internal Clock.

NOTE

- When you have an external MIDI device connected, the Master BPM is then synchronized to the external MIDI device’s tempo, thus disabling the Master BPM setting. To enable setting of the Master BPM, set to “Internal.”
- When synchronizing performances to the MIDI Clock signal from an external MIDI device, timing problems in the performance may occur due to errors in the MIDI Clock.

Sending Program Change Messages

This setting determines whether or not Program Change messages are output when patches are switched on the GT-10.

1. Follow the procedure in “Making the Settings for MIDI Functions” (p. 80) to move the cursor to “PC Out.”

2. Set the desired value.

Off	Program Change messages are not output, even when patches are switched.
On	Program Change messages are simultaneously output when patches are switched.



MEMO

- On the GT-10, Bank Select messages are output simultaneously with Program Change messages. For more details, refer to p. 85.

Sending EXP Pedal Operations as Control Change Messages

This sets the controller number when EXP Pedal operation data is output as Control Change messages.

1. Follow the procedure in “Making the Settings for MIDI Functions” (p. 80) to move the cursor to “EXP1 Out.”

2. Set the desired value.

Off	Control Change messages are not output.
CC#1–CC#31, CC#64–CC#95	This sets the controller number when EXP Pedal operation data is output as Control Change messages.



Sending EXP Pedal Sw Operations as Control Change Messages

This sets the controller number when EXP PEDAL SW operation data is output as Control Change messages.

1. Follow the procedure in “Making the Settings for MIDI Functions” (p. 80) to move the cursor to “EXP Sw Out.”

2. Set the desired value.

Off	Control Change messages are not output.
CC#1–CC#31, CC#64–CC#95	This sets the controller number when EXP PEDAL SW operation data is output as Control Change messages.



Sending External EXP Pedal Operations as Control Change Messages

This sets the controller number when operation data from the EXP PEDAL connected to the EXP PEDAL 2 jack is output as Control Change messages.

1. Follow the procedure in “Making the Settings for MIDI Functions” (p. 80) to move the cursor to “EXP2 Out.”

2. Set the desired value.

Off	Control Change messages are not output.
CC#1–CC#31, CC#64–CC#95	This sets the controller number when external EXP Pedal operation data is output as Control Change messages.



Sending CTL Pedal Operations as Control Change Messages

This sets the controller number when CTL 1 and CTL 2 pedal switch operation data is output as Control Change messages.

1. Follow the procedure in “Making the Settings for MIDI Functions” (p. 80) to move the cursor to “CTL1 Out” or “CTL2 Out.”
2. Set the desired value.



CC#1–CC#31,
CC#64–CC#95

This sets the controller number when CTL 1 and CTL2 pedal operation data is output as Control Change messages.

Sending External Footswitch Operations as Control Change Messages

This sets the controller number when operation data from the footswitch connected to the CTL 3,4 jack is output as Control Change messages.

1. Follow the procedure in “Making the Settings for MIDI Functions” (p. 80) to move the cursor to “CTL3 Out” or “CTL4 Out.”
2. Set the desired value.



CC#1–CC#31,
CC#64–CC#95

This sets the controller number when external footswitch operation data is output as Control Change messages.

Setting the Correspondences Between Program Change Messages and Patches (Program Change Map)

When switching patches using Program Change messages transmitted by an external MIDI device, you can freely set the correspondence between Program Change messages received by the GT-10 and the patches to be switched to in the “Program Change Map.”

MEMO

When setting MIDI Omni Mode (p. 81) to “Omni Off,” be sure to have the MIDI Rx Channel (p. 80) set beforehand to match the transmit channel of the external MIDI device.

Enabling/Disabling the Program Change Map Settings (MIDI Map Select)

This setting determines whether patches are switched according to the Program Change Map settings, or to the default settings.

- | | |
|---|---|
| 1. Follow the procedure in “Making the Settings for MIDI Functions” (p. 80) to move the cursor to “Map Select.” | |
| 2. Set the desired value. | |
|  | |
| Fix | This deactivates the Program Change Map. Switches to the patches according to the default settings. |
| Prog | This activates the Program Change Map. Switches to the patches according to the Program Change Map. |

Setting the Program Change Map

Set the correspondence between Program Change messages received and the patches to be switched.

1.  The SYSTEM MENU screen appears.

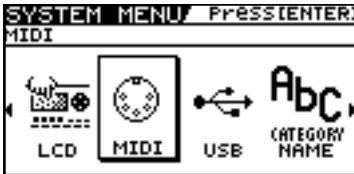
2.  Select MIDI.
- 
- The screenshot shows the SYSTEM MENU with 'MIDI' selected. Other options include LCD, USB, and CATEGORY NAME.

3.  The MIDI MENU screen appears.

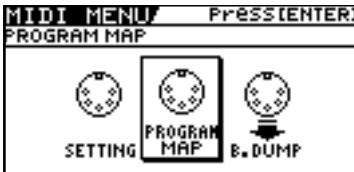
4.  Select PROGRAM MAP.
- 
- The screenshot shows the MIDI MENU with 'PROGRAM MAP' selected. Other options include SETTING and E.DUMP.

MEMO

The Program Change Map settings are disabled when Map Select is set to “Fix.”

- The PROGRAM MAP screen appears.

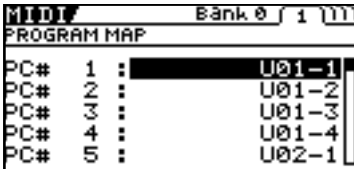
5.  The PROGRAM MAP screen appears.
- 
- The screenshot shows the PROGRAM MAP screen with a list of PC# values and their corresponding patch names (e.g., U01-1, U01-2, etc.).

MEMO

- Use the cursor buttons (left and right) to select the Bank Select number.
- When using only Program Change messages to make program changes, without using Bank Select messages, set the Program number (1–128) when the Bank Select number is “0.”



6. Select the received Program number.



7. Set the corresponding patch number of the received Program number.

8. Repeat Step 6–7 as needed, setting patch numbers to their corresponding Program numbers, until the Program Change Map is completed.

Changing Patches Using Bank Select Messages

A bank select message consists of a set of two control change messages, the controllers numbered 0 (CC#0) and 32 (CC#32). Normally, you select a sound by using the bank select message followed by a program change message. On the GT-10, these messages are used for changing patch numbers.

Changing Patch Numbers on an External MIDI Device from the GT-10

When a patch is selected on the GT-10, the bank select and program change messages sent from the GT-10 correspond with each other as shown below.

Bank	Number			
	1	2	3	4
U01	0,0: 1	0,0: 2	0,0: 3	0,0: 4
U02	0,0: 5	0,0: 6	0,0: 7	0,0: 8
U03	0,0: 9	0,0: 10	0,0: 11	0,0: 12
U04	0,0: 13	0,0: 14	0,0: 15	0,0: 16
U05	0,0: 17	0,0: 18	0,0: 19	0,0: 20
U06	0,0: 21	0,0: 22	0,0: 23	0,0: 24
U07	0,0: 25	0,0: 26	0,0: 27	0,0: 28
U08	0,0: 29	0,0: 30	0,0: 31	0,0: 32
U09	0,0: 33	0,0: 34	0,0: 35	0,0: 36
U10	0,0: 37	0,0: 38	0,0: 39	0,0: 40
U11	0,0: 41	0,0: 42	0,0: 43	0,0: 44
U12	0,0: 45	0,0: 46	0,0: 47	0,0: 48
U13	0,0: 49	0,0: 50	0,0: 51	0,0: 52
U14	0,0: 53	0,0: 54	0,0: 55	0,0: 56
U15	0,0: 57	0,0: 58	0,0: 59	0,0: 60
U16	0,0: 61	0,0: 62	0,0: 63	0,0: 64
U17	0,0: 65	0,0: 66	0,0: 67	0,0: 68
U18	0,0: 69	0,0: 70	0,0: 71	0,0: 72
U19	0,0: 73	0,0: 74	0,0: 75	0,0: 76
U20	0,0: 77	0,0: 78	0,0: 79	0,0: 80
U21	0,0: 81	0,0: 82	0,0: 83	0,0: 84
U22	0,0: 85	0,0: 86	0,0: 87	0,0: 88
U23	0,0: 89	0,0: 90	0,0: 91	0,0: 92
U24	0,0: 93	0,0: 94	0,0: 95	0,0: 96
U25	0,0: 97	0,0: 98	0,0: 99	0,0: 100
U26	1,0: 1	1,0: 2	1,0: 3	1,0: 4
U27	1,0: 5	1,0: 6	1,0: 7	1,0: 8
U28	1,0: 9	1,0: 10	1,0: 11	1,0: 12
U29	1,0: 13	1,0: 14	1,0: 15	1,0: 16
U30	1,0: 17	1,0: 18	1,0: 19	1,0: 20
U31	1,0: 21	1,0: 22	1,0: 23	1,0: 24
U32	1,0: 25	1,0: 26	1,0: 27	1,0: 28
U33	1,0: 29	1,0: 30	1,0: 31	1,0: 32
U34	1,0: 33	1,0: 34	1,0: 35	1,0: 36
U35	1,0: 37	1,0: 38	1,0: 39	1,0: 40

Bank	Number			
	1	2	3	4
U36	1,0: 41	1,0: 42	1,0: 43	1,0: 44
U37	1,0: 45	1,0: 46	1,0: 47	1,0: 48
U38	1,0: 49	1,0: 50	1,0: 51	1,0: 52
U39	1,0: 53	1,0: 54	1,0: 55	1,0: 56
U40	1,0: 57	1,0: 58	1,0: 59	1,0: 60
U41	1,0: 61	1,0: 62	1,0: 63	1,0: 64
U42	1,0: 65	1,0: 66	1,0: 67	1,0: 68
U43	1,0: 69	1,0: 70	1,0: 71	1,0: 72
U44	1,0: 73	1,0: 74	1,0: 75	1,0: 76
U45	1,0: 77	1,0: 78	1,0: 79	1,0: 80
U46	1,0: 81	1,0: 82	1,0: 83	1,0: 84
U47	1,0: 85	1,0: 86	1,0: 87	1,0: 88
U48	1,0: 89	1,0: 90	1,0: 91	1,0: 92
U49	1,0: 93	1,0: 94	1,0: 95	1,0: 96
U50	1,0: 97	1,0: 98	1,0: 99	1,0: 100
P01	2,0: 1	2,0: 2	2,0: 3	2,0: 4
P02	2,0: 5	2,0: 6	2,0: 7	2,0: 8
P03	2,0: 9	2,0: 10	2,0: 11	2,0: 12
P04	2,0: 13	2,0: 14	2,0: 15	2,0: 16
P05	2,0: 17	2,0: 18	2,0: 19	2,0: 20
P06	2,0: 21	2,0: 22	2,0: 23	2,0: 24
P07	2,0: 25	2,0: 26	2,0: 27	2,0: 28
P08	2,0: 29	2,0: 30	2,0: 31	2,0: 32
P09	2,0: 33	2,0: 34	2,0: 35	2,0: 36
P10	2,0: 37	2,0: 38	2,0: 39	2,0: 40
P11	2,0: 41	2,0: 42	2,0: 43	2,0: 44
P12	2,0: 45	2,0: 46	2,0: 47	2,0: 48
P13	2,0: 49	2,0: 50	2,0: 51	2,0: 52
P14	2,0: 53	2,0: 54	2,0: 55	2,0: 56
P15	2,0: 57	2,0: 58	2,0: 59	2,0: 60
P16	2,0: 61	2,0: 62	2,0: 63	2,0: 64
P17	2,0: 65	2,0: 66	2,0: 67	2,0: 68
P18	2,0: 69	2,0: 70	2,0: 71	2,0: 72
P19	2,0: 73	2,0: 74	2,0: 75	2,0: 76
P20	2,0: 77	2,0: 78	2,0: 79	2,0: 80

Bank	Number			
	1	2	3	4
P21	2,0: 81	2,0: 82	2,0: 83	2,0: 84
P22	2,0: 85	2,0: 86	2,0: 87	2,0: 88
P23	2,0: 89	2,0: 90	2,0: 91	2,0: 92
P24	2,0: 93	2,0: 94	2,0: 95	2,0: 96
P25	2,0: 97	2,0: 98	2,0: 99	2,0: 100
P26	3,0: 1	3,0: 2	3,0: 3	3,0: 4
P27	3,0: 5	3,0: 6	3,0: 7	3,0: 8
P28	3,0: 9	3,0: 10	3,0: 11	3,0: 12
P29	3,0: 13	3,0: 14	3,0: 15	3,0: 16
P30	3,0: 17	3,0: 18	3,0: 19	3,0: 20
P31	3,0: 21	3,0: 22	3,0: 23	3,0: 24
P32	3,0: 25	3,0: 26	3,0: 27	3,0: 28
P33	3,0: 29	3,0: 30	3,0: 31	3,0: 32
P34	3,0: 33	3,0: 34	3,0: 35	3,0: 36
P35	3,0: 37	3,0: 38	3,0: 39	3,0: 40
P36	3,0: 41	3,0: 42	3,0: 43	3,0: 44
P37	3,0: 45	3,0: 46	3,0: 47	3,0: 48
P38	3,0: 49	3,0: 50	3,0: 51	3,0: 52
P39	3,0: 53	3,0: 54	3,0: 55	3,0: 56
P40	3,0: 57	3,0: 58	3,0: 59	3,0: 60
P41	3,0: 61	3,0: 62	3,0: 63	3,0: 64
P42	3,0: 65	3,0: 66	3,0: 67	3,0: 68
P43	3,0: 69	3,0: 70	3,0: 71	3,0: 72
P44	3,0: 73	3,0: 74	3,0: 75	3,0: 76
P45	3,0: 77	3,0: 78	3,0: 79	3,0: 80
P46	3,0: 81	3,0: 82	3,0: 83	3,0: 84
P47	3,0: 85	3,0: 86	3,0: 87	3,0: 88
P48	3,0: 89	3,0: 90	3,0: 91	3,0: 92
P49	3,0: 93	3,0: 94	3,0: 95	3,0: 96
P50	3,0: 97	3,0: 98	3,0: 99	3,0: 100

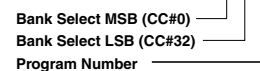

MEMO

- If you wish to know whether the receiving device can recognize bank select messages or not, refer to the description for control changes in the MIDI implementation chart provided in the owner’s manual of the receiving device.
- If the receiving device does not recognize bank select messages, it will ignore the bank select messages and recognize only the program change messages.

Changing Patch Numbers on the GT-10 from an External MIDI Device

When the MIDI Map Select parameter set to Fix, to change patch numbers on the GT-10 using bank select messages sent from an external MIDI device, check how the external bank select and program change messages correspond with the patch numbers on the GT-10.

Corresponding Table with the Patch Numbers when the MIDI Map Select is Fix

PC#	CC#0				PC#	CC#0				PC#	CC#0			
	0	1	2	3		0	1	2	3		0	1	2	3
1	U01-1	U26-1	P01-1	P26-1	36	U09-4	U34-4	P09-4	P34-4	71	U18-3	U43-3	P18-3	P43-3
2	U01-2	U26-2	P01-2	P26-2	37	U10-1	U35-1	P10-1	P35-1	72	U18-4	U43-4	P18-4	P43-4
3	U01-3	U26-3	P01-3	P26-3	38	U10-2	U35-2	P10-2	P35-2	73	U19-1	U44-1	P19-1	P44-1
4	U01-4	U26-4	P01-4	P26-4	39	U10-3	U35-3	P10-3	P35-3	74	U19-2	U44-2	P19-2	P44-2
5	U02-1	U27-1	P02-1	P27-1	40	U10-4	U35-4	P10-4	P35-4	75	U19-3	U44-3	P19-3	P44-3
6	U02-2	U27-2	P02-2	P27-2	41	U11-1	U36-1	P11-1	P36-1	76	U19-4	U44-4	P19-4	P44-4
7	U02-3	U27-3	P02-3	P27-3	42	U11-2	U36-2	P11-2	P36-2	77	U20-1	U45-1	P20-1	P45-1
8	U02-4	U27-4	P02-4	P27-4	43	U11-3	U36-3	P11-3	P36-3	78	U20-2	U45-2	P20-2	P45-2
9	U03-1	U28-1	P03-1	P28-1	44	U11-4	U36-4	P11-4	P36-4	79	U20-3	U45-3	P20-3	P45-3
10	U03-2	U28-2	P03-2	P28-2	45	U12-1	U37-1	P12-1	P37-1	80	U20-4	U45-4	P20-4	P45-4
11	U03-3	U28-3	P03-3	P28-3	46	U12-2	U37-2	P12-2	P37-2	81	U21-1	U46-1	P21-1	P46-1
12	U03-4	U28-4	P03-4	P28-4	47	U12-3	U37-3	P12-3	P37-3	82	U21-2	U46-2	P21-2	P46-2
13	U04-1	U29-1	P04-1	P29-1	48	U12-4	U37-4	P12-4	P37-4	83	U21-3	U46-3	P21-3	P46-3
14	U04-2	U29-2	P04-2	P29-2	49	U13-1	U38-1	P13-1	P38-1	84	U21-4	U46-4	P21-4	P46-4
15	U04-3	U29-3	P04-3	P29-3	50	U13-2	U38-2	P13-2	P38-2	85	U21-1	U47-1	P21-1	P47-1
16	U04-4	U29-4	P04-4	P29-4	51	U13-3	U38-3	P13-3	P38-3	86	U22-2	U47-2	P22-2	P47-2
17	U05-1	U30-1	P05-1	P30-1	52	U13-4	U38-4	P13-4	P38-4	87	U22-3	U47-3	P22-3	P47-3
18	U05-2	U30-2	P05-2	P30-2	53	U14-1	U39-1	P14-1	P39-1	88	U22-4	U47-4	P22-4	P47-4
19	U05-3	U30-3	P05-3	P30-3	54	U14-2	U39-2	P14-2	P39-2	89	U23-1	U48-1	P23-1	P48-1
20	U05-4	U30-4	P05-4	P30-4	55	U14-3	U39-3	P14-3	P39-3	90	U23-2	U48-2	P23-2	P48-2
21	U06-1	U31-1	P06-1	P31-1	56	U14-4	U39-4	P14-4	P39-4	91	U23-3	U48-3	P23-3	P48-3
22	U06-2	U31-2	P06-2	P31-2	57	U15-1	U40-1	P15-1	P40-1	92	U23-4	U48-4	P23-4	P48-4
23	U06-3	U31-3	P06-3	P31-3	58	U15-2	U40-2	P15-2	P40-2	93	U24-1	U49-1	P24-1	P49-1
24	U06-4	U31-4	P06-4	P31-4	59	U15-3	U40-3	P15-3	P40-3	94	U24-2	U49-2	P24-2	P49-2
25	U07-1	U32-1	P07-1	P32-1	60	U15-4	U40-4	P15-4	P40-4	95	U24-3	U49-3	P24-3	P49-3
26	U07-2	U32-2	P07-2	P32-2	61	U16-1	U41-1	P16-1	P41-1	96	U24-4	U49-4	P24-4	P49-4
27	U07-3	U32-3	P07-3	P32-3	62	U16-2	U41-2	P16-2	P41-2	97	U25-1	U50-1	P25-1	P50-1
28	U07-4	U32-4	P07-4	P32-4	63	U16-3	U41-3	P16-3	P41-3	98	U25-2	U50-2	P25-2	P50-2
29	U08-1	U33-1	P08-1	P33-1	64	U16-4	U41-4	P16-4	P41-4	99	U25-3	U50-3	P25-3	P50-3
30	U08-2	U33-2	P08-2	P33-2	65	U17-1	U42-1	P17-1	P42-1	100	U25-4	U50-4	P25-4	P50-4
31	U08-3	U33-3	P08-3	P33-3	66	U17-2	U42-2	P17-2	P42-2	:	:	:	:	:
32	U08-4	U33-4	P08-4	P33-4	67	U17-3	U42-3	P17-3	P42-3	:	:	:	:	:
33	U09-1	U34-1	P09-1	P34-1	68	U17-4	U42-4	P17-4	P42-4	:	:	:	:	:
34	U09-2	U34-2	P09-2	P34-2	69	U18-1	U43-1	P18-1	P43-1	:	:	:	:	:
35	U09-3	U34-3	P09-3	P34-3	70	U18-2	U43-2	P18-2	P43-2	128	U25-4	U50-4	P25-4	P50-4

MEMO

When using only Program Change messages to make program changes, without using Bank Select messages, set the Program number (1-128) when the Bank Select number is "0."



PC#: Program Number
 CC#0: Controller Number 0 (Bank Select MSB)

* CC#0 data of a value of 04H or higher, and the CC#32 are ignored.

(Example) When changing to Patch #30-3 (Bank U30, Number 3)

Transmit MIDI messages from an external MIDI sequencer in following order.

CC#0: 1
 PC#: 19

Transmitting Data to an External MIDI Device (Bulk Dump)

With the GT-10, you can use Exclusive messages to set another GT-10 to the same settings or to save effect sound settings to MIDI sequencers and other such devices. This transmission of data is referred to as bulk dump.

Making the Connections

When Saving to a MIDI Sequencer

Connect as shown in the figure below, and put the sequencer in the state where it is ready to receive Exclusive messages.

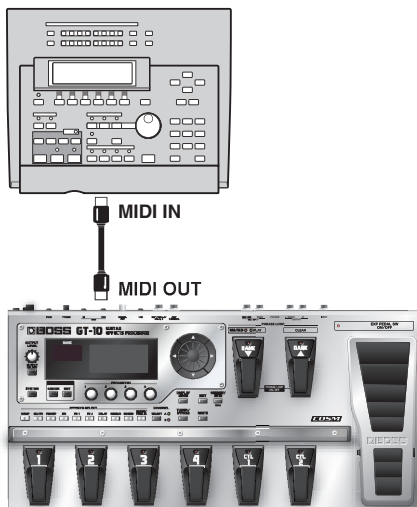

MEMO

For instructions on operating the sequencer, refer to the owner's manual for the sequencer you are using.

When Transmitting Data to Another GT-10

Connect as shown in the figure below, and match the Device ID for the transmitting and receiving devices.

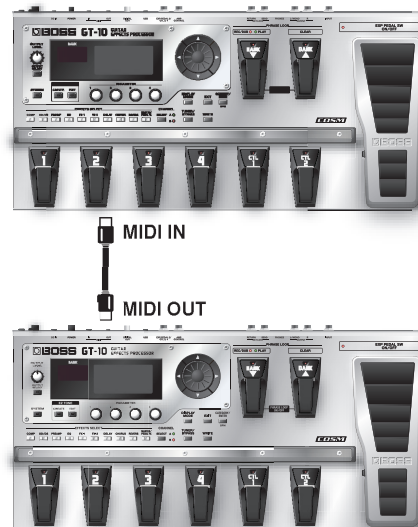

Transmitting

1.  The SYSTEM MENU screen appears.

2.  Select MIDI.

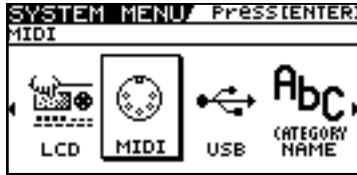

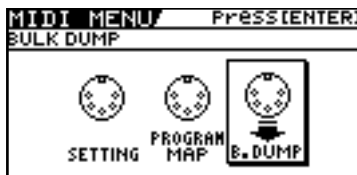

3.  The MIDI MENU screen appears.

4.  Select B.DUMP.

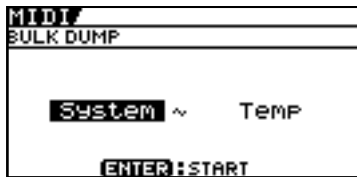

5.  The BULK DUMP screen appears.



6.  Select the start and end of the data to be transmitted.

The following types of data can be transmitted. You can transmit data by specifying the range from the start to the end of transmission.

Displayed	Data Transmitted
System	System parameter settings
Quick	Settings for User Quick Setting
U01-1-U50-4	Settings for Patch Number U01-1 through U50-4
Temp	Settings for the patch that is currently selected

7.  The data is transmitted.

Receiving Data from an External MIDI Device (Bulk Load)

You can restore settings by importing data that has been saved on a MIDI sequencer or the like by a bulk dump. This data-receiving operation is called a “bulk load.”

Making the Connections

When Receiving Data Saved on a MIDI Sequencer

Connect as shown below. Set the GT-10's Device ID to the same number that was used when the data was transmitted to the MIDI sequencer (p. 81).

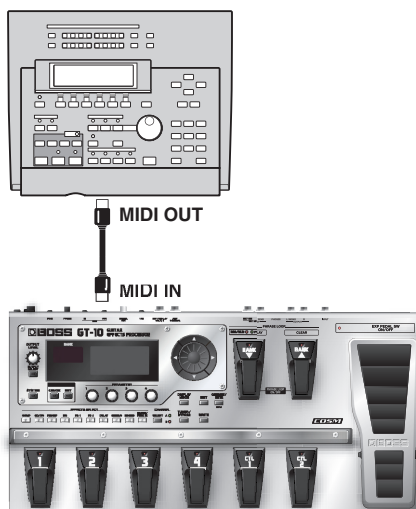

MEMO

For instructions on operating the sequencer, refer to the owner's manual for the sequencer you are using.

Receiving

1. Transmit the data from the external MIDI device.

MEMO

- When data is being received, the message “BULK DATA RECEIVING...” appears on the display.
- Keep the power on while the bulk data is being received.
- If the message “MIDI BUFFER FULL” appears, check the connections and reduce the tempo of the transmitting MIDI device.

Chapter 7 Using the GT-10 Connected to a Computer Via USB

Before Connecting with USB

With the GT-10, you can use USB to transmit both digital audio signals between the GT-10 and your computer.

Installing and Setting the USB Driver

Just by connecting the GT-10 to your PC/Mac with a USB cable, audio signal can be transferred bidirectionally via USB. The GT-10 uses a standard driver that is found on OS. The driver will be installed automatically once connected with your computer via USB.

And using the specialized driver, you can record, play back, and edit audio with high-quality sound and stable timing.

It also allows you to control the GT-10 using MIDI messages via USB.

You can download the special GT-10 driver from the Roland local website.

The program and procedures for installing the driver vary according to the operating environment; carefully read the Readme included in the downloaded file.

What is a USB Driver?

A USB driver is software that acts as a go-between in transferring data between computer applications (such as recording software and sequencer software) and the USB device when the computer and USB device are connected using a USB cable.

The USB driver transmits data from the applications to the USB device, and conversely, passes messages from the USB device to the applications.

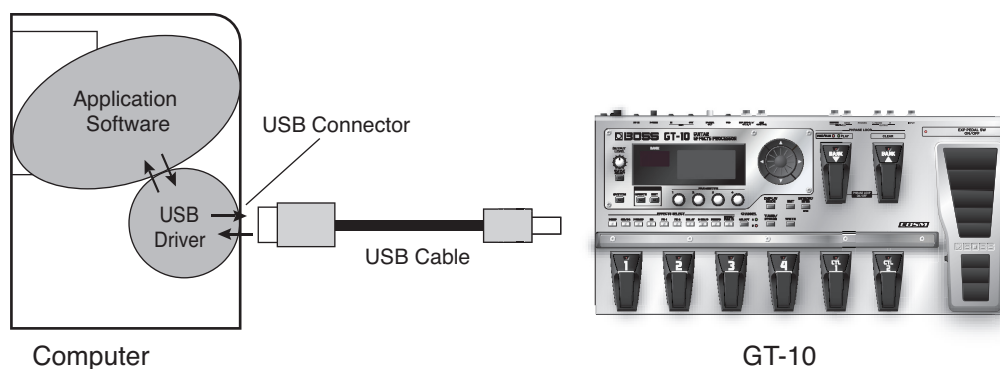

Exchanging MIDI Messages between the Computer and the GT-10

If you set the GT-10 into the specialized driver mode (p. 91) and connect it to your PC/Mac by a USB cable, you can transfer MIDI message bidirectionally via USB.

Set your computer MIDI input and output ports to “GT-10.”

If you set USB connection between the GT-10 and PC/Mac, MIDI message transfer via MIDI connectors become inactivated.

cf.

For more on MIDI-related settings, refer to “Making the Settings for MIDI Functions” (p. 80).

Switching the Driver Mode

Switches two operational modes, one which uses the special driver contained on the downloaded file, and one in which the OS's (Windows/Mac OS) standard driver is used.

1. Quit all sequencer software and other applications on the computer that are using the GT-10.

2.  The SYSTEM MENU screen appears.

Select USB.

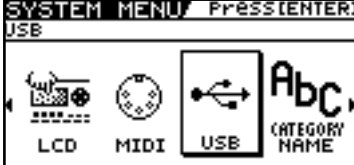
3.  

The USB screen appears.

4.  

5.  Move the cursor to Driver Mode.

6.  Select the Driver Mode.
"PLEASE RESTART" message appears.

Setting	Explanation
Standard	<p>This mode uses the OS's standard USB driver.</p> <p>MEMO You cannot use MIDI when Standard is selected as the driver mode. If you want to use MIDI with the USB connection, set the GT-10 to the advanced driver mode.</p>
Advanced	<p>This mode uses the special driver.</p> <p>MEMO If you have not yet installed the special driver for the Advanced mode, turn off the power to the GT-10 in this condition and install the driver.</p>

7. Turn the GT-10's power off and then back on again.

MEMO

The functions of a mode won't become available until after the power has been turned off, then on again.









Setting the USB Functions

The following section describes the GT-10's USB-related functions.

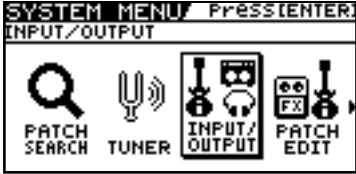
Make these settings in accordance with how you plan to use the GT-10.

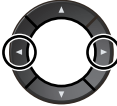
Setting the Digital Audio Signal Input and Output

This lets you adjust the volume level of the digital audio signals output from the GT-10 and adjust the amount of digital audio from USB (computer) to be mixed in.

- | | | |
|----|---|--|
| 1. |  | The SYSTEM MENU screen appears. |
| 2. |  | <p>Select INPUT/OUTPUT.</p>  |
| 3. |  | The INPUT/OUTPUT screen appears. |
| 4. |  | <p>Select the TOTAL (page 3) screen.</p>  |
| 5. |  | Move the cursor to USB/DGT Out Lev or USB Mix Level. |
| 6. |  | Adjust the parameters. |

Parameter	Explanation
USB/DGT Out Lev	Adjusts the volume level of the digital audio signals output to the USB (Computer) and DIGITAL OUT connectors.
USB Mix Level	Sets the volume level of the mixed digital audio signals from USB (Computer) when INPUT SELECT (p. 61) is set to "Guitar 1-3."

Setting the Direct Monitor

Switches the output of the GT-10 sound to the OUTPUT and PHONES jacks.

1.  The SYSTEM MENU screen appears.

Select USB.



The USB screen appears.



4.  Move the cursor to Dir. Monitor.

5.  Select the Monitor mode.

cf. 

For more information on signal paths set by the Direct Monitor parameter settings, refer to "Signal Flow" (p. 142).

Parameter/Range	Explanation
Off	Set this to Off if transmitting audio data internally through a computer (Thru). No sound is heard at this time unless the setting for the computer is Thru.
On	The GT-10 sound is output. Set this to On when using the GT-10 as a standalone device, without connecting to a computer (only USB In input sound will be output if this is set to Off).

MEMO

- This setting cannot be saved. It is set to On when the power is turned on.
- If you are using the special driver, you can control Dir. Monitor On/Off from ASIO 2.0-compatible application.

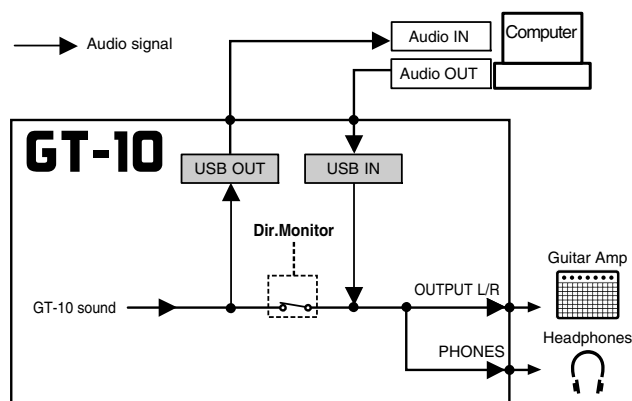

Controlling the Direct Monitor Setting from an External Device

This setting determines whether or not the command (the Direct Monitor command) controlling the Direct Monitor setting (p. 93) is enabled.

1.  The SYSTEM MENU screen appears.

2. Select USB.

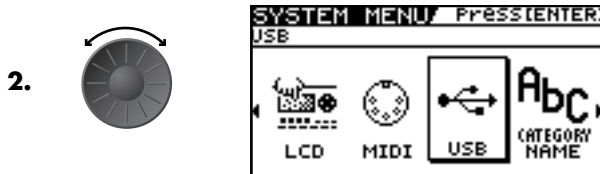

The USB screen appears.



4.  Move the cursor to Monitor Cmd.

5.  Set the desired value.

Parameter/Range	Explanation
Disable	The Direct Monitor command is disabled, maintaining the Direct Monitor mode set by the GT-10.
Enable	The Direct Monitor command is enabled, allowing the Direct Monitor mode to be switched from an external device.

Recording the GT-10's Output with a Computer

In the computer application, set the audio input port to the GT-10.

MEMO

If passing audio data through the software you're using, switch the direct monitor off.

Applying GT-10 Effects to a Computer's Audio Playback

In the computer application, set the audio output port to the GT-10.

You can use the GT-10 to apply effects to the audio data played by the computer, then record the data again with the computer.

Use this process when, for example, you want to add effects to existing audio data.

MEMO

Set the software so audio is not passed through it.

1.  The SYSTEM MENU screen appears.

Select INPUT/OUTPUT.

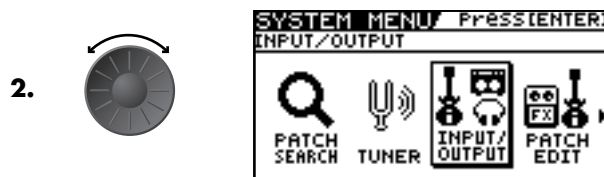

3.  The INPUT/OUTPUT screen appears.

Set the INPUT SELECT parameter to USB In.

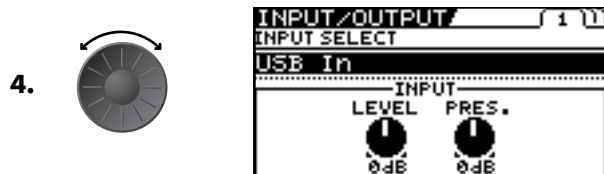

MEMO

Set the software so audio is not passed through it.

Parameter/Range	Explanation
Guitar 1-3	Effects are applied to the signals input via the INPUT jacks.
USB In	Effects are applied to the signals input via USB.

Chapter 8 Parameters Guide

In this chapter you will find detailed descriptions for each of the GT-10's effects and the parameters used to control them.

MEMO

The format used for parameter names is based on how the names are displayed when the screen is in list view.

The trademarks listed in this document are trademarks of their respective owners, which are separate companies from Roland/BOSS. Those companies are not affiliated with Roland/BOSS and have not licensed or authorized BOSS's GT-10. Their marks are used solely to identify the equipment whose sound is simulated.

COMP (Compressor)

This is an effect that produces a long sustain by evening out the volume level of the input signal. You can switch it to a limiter to suppress only the sound peaks and prevent distortion.

Parameter/Range	Explanation
COMP ON/OFF (Compressor ON/OFF)	
Off, On	Turns the COMP effect on/off. Pressing [COMP] switches On and Off.
TYPE	
Select the compressor type.	
Compressor	The effect will function as a compressor.
Limiter	The effect will function as a limiter.
Sustain (Type=Compressor)	
0-100	Adjusts the range (time) over which low-level signals are boosted. Larger values will result in longer sustain.
Attack (Type=Compressor)	
0-100	Adjusts the strength of the picking attack when the strings are played. Higher values result in a sharper attack, creating a more clearly defined sound.
Threshold (Type=Limiter)	
0-100	When the input signal level exceeds this threshold level, limiting will be applied.
Release (Type=Limiter)	
0-100	Adjusts the time from when the signal level drops below the threshold until when limiting is removed.
Tone	
-50+50	Adjusts the tone.
Level	
0-100	Adjusts the volume.

OD/DS (Overdrive/Distortion)

This effect distorts the sound to create long sustain. It provides 30 types of distortion and custom settings.

Parameter/Range	Explanation	
OD/DS (Overdrive/Distortion ON/OFF)		
Off, On	Turns the OD/DS effect on/off. Pressing [OD/DS] switches On and Off.	
Type		
Selects the type of distortion.		
BOOSTER	Mid Boost	This is a booster with unique characteristics in the midrange. Making the connection before the COSM amp produces sound suitable for solos.
	Clean Boost	This not only functions as a booster, but also produces a clean tone that has punch even when used alone.
	Treble Bst	This is a booster that has bright characteristics.
BLUES	Blues OD	This is a crunch sound of the BOSS BD-2. This produces distortion that faithfully reproduces the nuances of picking.
	Crunch	A lustrous crunch sound with an added element of amp distortion.
	Natural OD	This is an overdrive sound that provides distortion with a natural feeling.
OD	OD-1	This is the sound of the BOSS OD-1. This produces sweet, mild distortion.
	T-Scream	This models an Ibanez TS-808.
	Turbo OD	This is the high-gain overdrive sound of the BOSS OD-2.
	Warm OD	This is a warm overdrive.
DIST	Distortion	This gives a basic, traditional distortion sound.
	Mild DS	This is a distortion sound that provides a mild distortion.
	Mid DS	This distortion sound features a boosted midrange.
CLASSIC	RAT	This models a Proco RAT.
	GUV DS	This models a Marshall GUV' NOR.
	DST+	This models a MXR DISTORTION+.

Parameter/Range	Explanation
MODERN	Modern DS This is the deep distortion sound of a large high-gain amp.
	Solid DS This is a distortion sound featuring an edge effect.
	Stack A fat sound with an added element of a stack amp's distortion.
METAL	Loud This is distortion sound that is ideal for performances of heavy riffs.
	Metal Zone This is the sound of the BOSS MT-2. It produces a wide range of metal sounds, from old style to slash metal.
	Lead Produces a distortion sound with both the smoothness of an overdrive along with a deep distortion.
FUZZ	'60s FUZZ This models a FUZZFACE. It produces a fat fuzz sound.
	Oct FUZZ This models an ACETONE FUZZ.
	MUFF FUZZ This models an Electro-Harmonix Big Muff π .
Custom Custom OD/DS You can customize it however you like to match the sound you want.	
Drive	
0-120	Adjusts the depth of distortion.
Bottom	
-50+50	Adjusts the tone for the low frequency range. Turning this to the left (counter-clockwise) produces a sound with the low end cut; turning it to the right boosts the low end in the sound.
Tone	
-50+50	Adjusts the tone.
Solo Sw	
Off, On	The tone to one suitable for solos.
SoloLevel	
0-100	Adjusts the volume level when the Solo Sw is ON.
EffectLev (Effect Level)	
0-100	Adjusts the volume of the OD/DS sound.
DirectLev (Direct Level)	
0-100	Adjusts the volume of the direct sound.

Parameter/Range	Explanation
CUSTOM TYPE SETTING	
MEMO Setting available when TYPE is set to Custom.	
Type	
This selects the basic sound when the TYPE parameter is set to Custom.	
OD-1	This is the sound of the BOSS OD-1.
OD-2	This is an overdrive sound with high gain.
CRUNCH	This is a crunch sound.
DS-1	This gives a basic, traditional distortion sound.
DS-2	This creates a heavier distortion sound.
METAL-1	This is a metal sound with a characteristic midrange.
METAL-2	This gives a heavy metal sound.
FUZZ	This gives a basic, traditional fuzz sound.
Bottom	
-50+50	This controls the input sound's low-frequency range and adjusts the amount of distortion in the low-frequency range.
Top	
-50+50	This controls the input sound's high-frequency range and adjusts the amount of distortion in the high-frequency range.
Low	
-50+50	Adjusts the low-range tones after distortion is applied.
High	
-50+50	Adjusts the high-range tones after distortion is applied.

Chapter 8 Parameters Guide

PREAMP

COSM technology simulates different preamp characteristics, speaker sizes, and cabinet shapes.

MEMO

You can make separate settings for Channel A and Channel B.

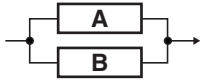
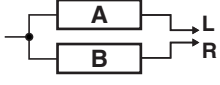
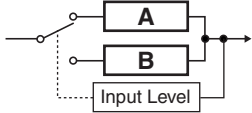
Parameter/Range	Explanation
PREAMP ON/OFF	
Off, On	Turns the COSM AMP effect on/off. Pressing [PREAMP] switches On and Off.
Ch.Mode (Channel Mode)	
Selects how the two channels are to be used.	
Single	Only the channel selected with Channel Select is used. 
Dual Mono	The output of Channels A and B is mixed. 
Dual L/R	Channel A is output from the left and Channel B is output from the right. 
Dynamic	Channels A and B are switched according to the guitar input volume level. This produces dynamic tonal changes in response to the picking dynamics. 
Ch.Select (Channel Select)	
Ch.A, Ch.B	Selects the preamp channel whose settings are to be changed.
Ch.DlyTim (Channel Delay Time)	
0ms-100ms	The output from Channel B is slightly delayed. Adjusting this increases the sense of depth and breadth in the sound. MEMO This parameter is enabled when Channel mode is set to Dual Mono or Dual L/R.
Dyna.Sens (Dynamic Sensitivity)	
0-100	Adjusting the sensitivity in response to the input level changes the timing of the channel switches. MEMO This parameter is enabled when Channel mode is set to Dynamic.

Preamp Type List

Parameter/Range	Explanation	
Type		
This sets the type of the guitar preamp.		
JC CLEAN	BOSS Clean	This is a clean sound that is smooth and warm.
	JC-120	This is the sound of the Roland JC-120.
	Jazz Combo	This is a sound suited to jazz.
TW CLEAN	Full Range	This is a sound with flat response. Good for acoustic guitar
	Clean TWIN	This models a Fender Twin Reverb.
	Pro Crunch	This models a Fender Pro Reverb.
CRUNCH	Tweed	This models a Fender Bassman 4 x 10" Combo.
	DELUX Crnch	This models a Fender Deluxe Reverb.
	BOSS Crunch	This is a crunch sound that can faithfully reproduce the nuances of picking.
COMBO	Blues	This is a sound suited to blues.
	Wild Crunch	This is a crunch sound with wild distortion.
	StackCrunch	This is a crunch sound with high gain.
MATCH	VO Drive	This models the drive sound of a VOX AC-30TB. This is a sound that it suited to sixties-style British rock.
	VO Lead	This models the lead sound of the VOX AC-30TB.
	VO Clean	This models the clean sound of the VOX AC-30TB.
BG LEAD	MATCH Drive	This models the sound input to left input on a Matchless D/C-30. A simulation of the latest tube amp widely used in styles from blues and rock.
	Fat MATCH	This models the sound of a Matchless with a modified high gain.
	MATCH Lead	This models the sound input to right input on a Matchless D/C-30.
MS CLASSIC	BG Lead	This models the lead sound of the MESA/Boogie combo amp. The sound of a tube amp typical of the late '70s to '80s.
	BG Drive	This models a MESA/Boogie with TREBLE SHIFT SW on.
	BG Rhythm	This models the rhythm channel of a MESA/Boogie.
MS MODERN	MS1959 I	This models the sound input to Input I on a Marshall 1959. This is a treble sound suited to hard rock.
	MS1959 I+II	The sound of connecting inputs I and II of the guitar amp in parallel, creating a sound with a stronger low end than I.
MS MODERN	MS HiGain	This models the sound of a Marshall with a modified midrange boost.
	MS Scoop	This is a Marshall sound that's been tweaked for metal sound.

Parameter/Range	Explanation
R-FIER	R-FIER Vnt Models the sound of the Channel 2 VINTAGE Mode on the MESA/Boogie DUAL Rectifier.
	R-FIER Mdn Models the sound of the Channel 2 MODERN Mode on the MESA/Boogie DUAL Rectifier.
	R-FIER Cln Models the sound of the Channel 1 CLEAN Mode on the MESA/Boogie DUAL Rectifier.
T-AMP	T-AMP Lead This models a Hughes & Kettner Triamp AMP3.
	T-AMP Crnch This models a Hughes & Kettner Triamp AMP2.
	T-AMP Clean This models a Hughes & Kettner Triamp AMP1.
HI-GAIN	BOSS Drive This is a drive sound producing awesome distortion.
	SLDN This models a Soldano SLO-100. This is the typical sound of the eighties.
	Lead Stack This is a lead sound with high gain.
	Heavy Lead A powerful lead sound featuring extreme distortion.
METAL	BOSS Metal This is a metal sound suited to heavy riffs.
	5150 Drive This models the lead channel of a Peavey EVH 5150.
	Metal Lead This is a lead sound suited to metal.
	Edge Lead This is a sharp sound suited for lead play.
Custom This is a custom preamp. You can customize it however you like to match the sound you want.	
Through This switches off the preamp for the channel selected using Ch.Select.	

JC CLEAN/TW CLEAN/CRUNCH/COMBO/BG LEAD/MS STACK/R-FIER/T-AMP/HI-GAIN/METAL

Parameter/Range	Explanation
Gain	
0-120	Adjusts the distortion of the amp.
Bass	
0-100	Adjusts the tone for the low frequency range.
Middle	
0-100	Adjusts the tone for the middle frequency range.
Treble	
0-100	Adjusts the tone for the high frequency range.
Presence	
0-100	Adjusts the tone for the ultra high frequency range. MEMO You set the Type parameter to VO Drive, VO Lead, VO Clean, MATCH Drive, Fat MATCH or MATCH Lead when the Presence parameter is functioning as the high cut filter.
Level	
0-100	Adjusts the volume of the entire preamp. * Be careful not to raise the Level setting too high.
Bright	
Turns the bright setting on/off.	
MEMO The BRIGHT parameter setting is only partially available with some JC CLEAN, TW CLEAN, CRUNCH, or BG LEAD settings in Preamp Type.	
Off	Bright is not used.
On	Bright is switched on to create a lighter and crisper tone.
Gain Sw	
Low, Middle, High	Provides for selection from three levels of distortion: LOW, MIDDLE, and HIGH. Distortion will successively increase for settings of LOW, MIDDLE and HIGH. * The sound of each Type is created on the basis that the Gain is set to MIDDLE. So, normally set it to MIDDLE.
Solo Sw	
Off, On	Solo Sw is switched on to create the tone to one suitable for solos.
SoloLevel	
0-100	Adjusts the volume level when the Solo Sw is ON.
SP Type (Speaker Type)	
Select the speaker type.	
Off	This turns off the speaker simulator.
Original	This is the built-in speaker of the amp you selected with PREAMP TYPE.

Chapter 8 Parameters Guide

Parameter/Range	Explanation
1x8"	This is a compact open-back speaker cabinet with one 8-inch speaker.
1x10"	This is a compact open-back speaker cabinet with one 10-inch speaker.
1x12"	This is a compact open-back speaker cabinet with one 12-inch speaker.
2x12"	This is a general open-back speaker cabinet with two 12-inch speakers.
4x10"	This is an optimal speaker cabinet for a large enclosed amp with four 10-inch speakers.
4x12"	This is an optimal speaker cabinet for a large enclosed amp with four 12-inch speakers.
8x12"	This is a double stack of two cabinets, each with four 12-inch speakers.
Custom	Custom speaker You can customize it however you like to match the sound you want.
Mic Type	
This setting selects the simulated mic type.	
DYN57	This is the sound of the SHURE SM-57. General dynamic mic used for instruments and vocals. Optimal for use in miking guitar amps.
DYN421	This is the sound of the SENNHEISER MD-421. Dynamic mic with extended low end.
CND451	This is the sound of the AKG C451B. Small condenser mic for use with instruments.
CND87	This is the sound of the NEUMANN U87. Condenser mic with flat response.
FLAT	Simulates a mic with perfectly flat response. Produces a sonic image close to that of listening to the sound directly from the speakers (on site).
Mic Dis (Mic Distance)	
Simulates the distance between the mic and speaker.	
Off Mic	This setting points the mic away from the speaker.
On Mic	Provides conditions whereby the mic is directed more towards the speaker.
Mic Pos. (Mic Position)	
This simulates the mic position.	
Center	Simulates the condition that the mic is set in the middle of the speaker cone.
1–10cm	Simulates the condition that the mic is moved away from the center of the speaker cone.
Mic Level	
0–100	Adjusts the volume of the mic.
DirectLev (Direct Level)	
0–100	Adjusts the volume of the direct sound.

Custom

Parameter/Range	Explanation
CUSTOM AMP SETTING	
MEMO	
Setting available when Type is set to Custom.	
Type	
Selects the basic type of preamp.	
JC Clean	This is the sound of the Roland JC-120.
TW Clean	This models a Fender Twin Reverb.
Crunch	This is a crunch sound that can produce natural distortion.
VO Drive	This models the drive sound of a VOX AC-30TB.
BG Lead	This models the lead sound of the MESA/Boogie combo amp.
MS HiGain	This models the sound of a Marshall with a modified midrange boost.
Modern Stk	Models the sound of the Channel 2 MODERN Mode on the MESA/Boogie DUAL Rectifier.
Bottom	
-50+50	This controls the input sound's low-frequency range and adjusts the amount of distortion in the low-frequency range.
Edge	
-50+50	This controls the input sound's high-frequency range and adjusts the amount of distortion in the high-frequency range.
Bass Freq (Bass Frequency)	
-50+50	Adjusts the frequency affected by the BASS knob.
Tre Freq (Treble Frequency)	
-50+50	Adjusts the frequency affected by the TREBLE knob.
PreampLow	
-50+50	Adjusts the preamp section's low-frequency tone.
Preamp Hi (Preamp High)	
-50+50	Adjusts the preamp section's high-frequency tone.

Parameter/Range	Explanation
CUSTOM SPEAKER SETTING	
MEMO Setting available when SP Type is set to Custom.	
SP Size (Speaker Size)	
5"–15"	Selects the size of speaker.
Color Low	
-10→+10	Adjusts the speaker section's low-frequency tone.
ColorHigh	
-10→+10	Adjusts the speaker section's high-frequency tone.
SP Number (Speaker Number)	
x1, x2, x4, x8	Sets the number of speakers.
Cabinet	
Selects the speaker cabinet type.	
Open	This is an open-backed cabinet.
Close	This type of cabinet features an enclosed rear panel.

EQ (Equalizer)

This adjusts the tone as a equalizer. A parametric type is adopted for the high-middle and low-middle range.

Parameter/Range	Explanation
EQ ON/OFF (Equalizer ON/OFF)	
Off, On	Turns the EQ effect on/off. Pressing [EQ] switches On and Off.
Low Cut (Low Cut Filter)	
Flat, 55Hz–800Hz	This sets the frequency at which the low cut filter begins to take effect. When "Flat" is selected, the low cut filter will have no effect.
Low Gain	
-20→+20dB	Adjusts the low frequency range tone.
Lo-Mid f (Low Middle Frequency)	
20Hz–10.0kHz	Specifies the center of the frequency range that will be adjusted by the Lo-Mid G.
Lo-Mid Q (Low Middle Q)	
0.5–16	Adjusts the width of the area affected by the EQ centered at the LO-Mid f. Higher values will narrow the area.
Lo-Mid G (Low Middle Gain)	
-20→+20dB	Adjusts the low-middle frequency range tone.
Hi-Mid f (High Middle Frequency)	
20Hz–10.0kHz	Specifies the center of the frequency range that will be adjusted by the Hi-Mid G.
Hi-Mid Q (High Middle Q)	
0.5–16	Adjusts the width of the area affected by the EQ centered at the Hi-Mid f. Higher values will narrow the area.
Hi-Mid G (High Middle Gain)	
-20→+20dB	Adjusts the high-middle frequency range tone.
High Gain	
-20→+20dB	Adjusts the high frequency range tone.
High Cut (High Cut Filter)	
700Hz–11kHz, Flat	This sets the frequency at which the high cut filter begins to take effect. When "Flat" is selected, the high cut filter will have no effect.
Level	
-20→+20dB	Adjusts the overall volume level of the equalizer.

FX-1/FX-2

With FX-1 and FX-2, you can select the effect to be used from the following. You can select the same effect for FX-1 and FX-2.

FX Select			
FX-1/FX-2 Common	T.WAH	Touch Wah	p. 102
	AUTO WAH	Auto Wah	p. 103
	SUB WAH	Sub Wah	p. 103
	ADV.COMP	Advanced Compressor	p. 104
	LIMITER	Limitter	p. 104
	GRAPHIC EQ	Graphic Equalizer	p. 104
	PARA EQ	Parametric Equalizer	p. 105
	TONE MODIFY	Tone Modify	p. 105
	GUITAR SIM.	Guitar Simulator	p. 106
	SLOW GEAR	Slow Gear	p. 106
	DEFRETTTER	Defretter	p. 106
	WAVE SYNTH	Wave Synth	p. 107
	GUITAR SYNTH	Guitar Synth	p. 107
	SITAR SIM.	Sitar Simulator	p. 108
	OCTAVE	Octave	p. 109
	PITCH SHIFTER	Pitch Shifter	p. 109
	HARMONIST	Harmonist	p. 110
	AUTO RIFF	Auto Riff	p. 111
	SOUND HOLD	Sound Hold	p. 112
	AC.PROCESSOR	Acoustic Processor	p. 112
	FEEDBACKER	Feedbacker	p. 113
	ANTI-FEEDBACK	Anti Feedback	p. 113
	PHASER	Phaser	p. 114
	FLANGER	Flanger	p. 114
	TREMOLO	Tremolo	p. 115
	ROTARY	Rotary	p. 115
	UNI-V	Uni-V	p. 115
	PAN	Pan	p. 115
	SLICER	Slicer	p. 116
	VIBRATO	Vibrato	p. 116
	RING MOD.	Ring Modulator	p. 117
	HUMANIZER	Humanizer	p. 117
2X2 CHORUS	2x2 Chorus	p. 118	
SUB DELAY	Sub Delay	p. 118	

T.WAH (Touch Wah)



You can produce a wah effect with the filter changing in response to the guitar level.

Parameter/Range	Explanation
Mode	
Selects the wah mode.	
LPF	This creates a wah effect over a wide frequency range.
BPF	This creates a wah effect in a narrow frequency range.
Polarity	
Selects the direction in which the filter will change in response to the input.	
Up	The frequency of the filter will rise.
Down	The frequency of the filter will fall.
Sens (Sensitivity)	
0-100	Adjusts the sensitivity at which the filter will change in the direction determined by the polarity setting. Higher values will result in a stronger response. With a setting of 0, the strength of picking will have no effect.
Frequency	
0-100	Adjusts the center frequency of the Wah effect.
Peak	
Adjusts the way in which the wah effect applies to the area around the center frequency.	
0-100	Higher values will produce a stronger tone which emphasizes the wah effect more. With a value of 50 a standard wah sound will be produced.
EffectLev (Effect Level)	
0-100	Adjusts the volume of the effect sound.
DirectLev (Direct Level)	
0-100	Adjusts the volume of the direct sound.

Parameter/Range	Explanation
FX-1, FX-2 ON/OFF (Effect ON/OFF)	
Off, On	Turns the FX-1 (FX-2) effect on/off. Pressing [FX-1], [FX-2] switches On and Off.
FX Select	
see above	Selects the effect to be used.

AUTO WAH (Auto Wah)

This changes the filtering over a periodic cycle, providing an automatic wah effect.

Parameter/Range	Explanation
Mode	
Selects the wah mode.	
LPF	This creates a wah effect over a wide frequency range.
BPF	This creates a wah effect in a narrow frequency range.
Frequency	
0–100	Adjusts the center frequency of the Wah effect.
Peak	
0–100	Adjusts the amount of wah effect applied in the range near the center frequency. Higher values will produce a stronger tone which emphasizes the wah effect more. With a value of 50 a standard wah sound will be produced.
Rate	
0–100, BPM  –BPM 	Adjusts the frequency (speed) of the change.
When set to BPM, the value of each parameter will be set according to the value of the “Master BPM” (p. 122) specified for each patch. This makes it easier to achieve effect sound settings that match the tempo of the song.	
* If, due to the tempo, the time is longer than the range of allowable settings, it is then synchronized to a period either 1/2 or 1/4 of that time.	
Depth	
0–100	Adjusts the depth of the effect.
EffectLev (Effect Level)	
0–100	Adjusts the volume of the effect sound.
DirectLev (Direct Level)	
0–100	Adjusts the volume of the direct sound.

SUB WAH

You can control the wah effect in real time by adjusting the EXP Pedal or the expression pedal connected to the EXP PEDAL 2 jack.

Parameter/Range	Explanation
Type	
Selects the type of wah.	
CRY WAH	This models the sound of the CRY BABY wah pedal popular in the '70s.
VO WAH	This models the sound of the VOX V846.
Fat WAH	This is a wah sound featuring a bold tone.
Light WAH	This wah has a refined sound with no unusual characteristics.
7string WAH	This expanded wah features a variable range compatible with seven-string and baritone guitars.
Reso WAH	This completely original effect offers enhancements on the characteristic resonances produced by analog synth filters.
Pedal Pos (Pedal Position)	
0–100	Adjusts the position of the wah pedal. MEMO This parameter is used after it's been assigned to an EXP Pedal or similar controller.
Pedal Min (Pedal Minimum)	
0–100	Selects the tone produced when the heel of the EXP Pedal is depressed.
Pedal Max (Pedal Maximum)	
0–100	Selects the tone produced when the toe of the EXP Pedal is depressed.
EffectLev (Effect Level)	
0–100	Adjusts the volume of the effect sound.
DirectLev (Direct Level)	
0–100	Adjusts the volume of the direct sound.

ADV.COMP (Advanced Compressor)

This is an effect that produces a long sustain by evening out the volume level of the input signal. You can also use it as a limiter to suppress only the sound peaks and prevent distortion.

Parameter/ Range	Explanation
Type	
Selects the compressor type.	
BOSS Comp	This models a BOSS CS-3.
Hi-BAND	This is a compressor that adds an even stronger effect in the high end.
Light	This is a compressor with a light effect.
D-Comp	This models a MXR DynaComp.
ORANGE	This is modeled on the sound of the Dan Armstrong ORANGE SQUEEZER.
Fat	When applied heavily, this compressor effect provides a fat tone with a boosted midrange.
Mild	When applied heavily, this compressor effect produces a sweet tone with the high end cut.
Stereo Comp	This selects a stereo compressor.
Sustain	
0–100	Adjusts the range (time) over which low-level signals are boosted. Larger values will result in longer sustain.
Attack	
0–100	Adjusts the attack time.
Tone	
-50→+50	Adjusts the tone.
Level	
0–100	Adjusts the volume.

LIMITER

The limiter attenuates loud input levels to prevent distortion.

Parameter/ Range	Explanation
Type	
Selects the limiter type.	
BOSS Limitr	This selects a stereo limiter.
Rack 160D	This models a dbx 160X.
Vtg Rack U	This models a UREI 1178.
Attack	
0–100	Adjusts the attack time.
Threshold	
0–100	Adjust this as appropriate for the input signal from your guitar. When the input signal level exceeds this threshold level, limiting will be applied.
Ratio	
1:1–∞:1	This selects the compression ratio used with signals in excess of the threshold level.
Release	
0–100	Adjusts the release time.
Level	
0–100	Adjusts the volume.

GRAPHIC EQ (Graphic Equalizer)

This adjusts the tone as an equalizer. You can adjust the sound quality in ten bands.

Parameter	Range
31Hz	-12→+12dB
62Hz	
125Hz	
250Hz	
500Hz	
1kHz	
2kHz	
4kHz	
8kHz	
16kHz	
Level	-12→+12dB

PARA EQ (Parametric Equalizer)

Adjusts the tonal quality. You can adjust the sound quality in four bands.

Parameter/Range	Explanation
Low Cut (Low Cut Filter)	
Flat, 55Hz–800Hz	This sets the frequency at which the low cut filter begins to take effect. When “Flat” is selected, the low cut filter will have no effect.
Low Gain	
-20→+20dB	Adjusts the low frequency range tone.
Lo-Mid f (Low Middle Frequency)	
20Hz–10.0kHz	Specify the center of the frequency range that will be adjusted by the “Lo-Mid G.”
Lo-Mid Q (Low Middle Q)	
0.5–16	Adjusts the width of the area affected by the EQ centered at the “Lo-Mid f.” Higher values will narrow the area.
Lo-Mid G (Low Middle Gain)	
-20→+20dB	Adjusts the low-middle frequency range tone.
Hi-Mid f (High Middle Frequency)	
20Hz–10.0kHz	Specify the center of the frequency range that will be adjusted by the “Hi-Mid G.”
Hi-Mid Q (High Middle Q)	
0.5–16	Adjusts the width of the area affected by the EQ centered at the “Hi-Mid f.” Higher values will narrow the area.
Hi-Mid G (High Middle Gain)	
-20→+20dB	Adjusts the high-middle frequency range tone.
High Gain	
-20→+20dB	Adjusts the high frequency range tone.
High Cut (High Cut Filter)	
700Hz–11kHz, Flat	This sets the frequency at which the high cut filter begins to take effect. When “Flat” is selected, the high cut filter will have no effect.
Level	
-20→+20dB	Adjusts the volume before the equalizer.

TONE MODIFY

This changes the tone of the connected guitar.

Parameter/Range	Explanation
Type	
Selects the type of tone modification.	
Fat	Fat tone with boosted mid range.
Presence	Bright tone with boosted high-mid range.
Mild	Mild tone with the high end cut back.
Tight	Tone with the low frequencies cut.
Enhance	Tone with the high frequencies boosted.
Resonator 1, 2, 3	This produces a tone with greater power and punch by adding resonance in the low-frequency range and midrange.
Resonance	
0–100	This adjusts the strength of the low-end and midrange resonance when Type is set to Resonator 1, 2, or 3.
Low	
-50→+50	Adjusts the tone for the low frequency range.
High	
-50→+50	Adjusts the tone for the High frequency range
Level	
0–100	Adjusts the volume.

GUITAR SIM. (Guitar Simulator)

Simulation of the characteristics of particular guitar components such as pickups and different guitar bodies allows you to switch among a number of different guitar types all while using a single guitar.

Parameter/Range	Explanation
Type	
Selects the type of the guitar simulator.	
'S'→'H'	Changes from a single-coil pickup tone to a humbucking pickup tone.
'H'→'S'	Changes from a humbucking pickup tone to a single-coil pickup tone.
'H'→'HF'	Changes from a humbucking pickup tone to a single-coil pickup half tone.
'S'→Hollow	Changes a single-coil pickup tone to a full-acoustic tone with the body resonance added.
'H'→Hollow	Changes a humbucking pickup tone to a full-acoustic tone with the body resonance added.
'S'→AC	Changes a single-coil pickup tone to an acoustic guitar tone.
'H'→AC	Changes a humbucking pickup tone to an acoustic guitar tone.
'P'→AC	Changes a piezo pickup tone to an acoustic guitar tone.
Low	
-50→+50	Adjusts the tone for the low frequency range.
High	
-50→+50	Adjusts the tone for the High frequency range
Body	
0-100	Adjusts the way the body sounds when Type is set to 'S' → Hollow, 'H' → Hollow, 'S' → AC, 'H' → AC, or 'P' → AC. The body sound increases as the value is raised; reducing the value produces a tone similar to that from a piezo pickup.
Level	
0-100	Adjusts the volume.

SLOW GEAR

This produces a volume-swell effect ("violin-like" sound).

Parameter/Range	Explanation
Sens (Sensitivity)	
0-100	Adjusts the sensitivity of the slow gear. When it is set to a lower value, the effect of the slow gear can be obtained only with a stronger picking, while no effect is obtained with a weaker picking. When the value is set higher, the effect is obtained even with a weak picking.
Rise Time	
0-100	Adjusts the time needed for the volume to reach its maximum from the moment you begin picking.



DEFRETTER

This simulates a fretless guitar.

Parameter/Range	Explanation
Tone	
-50→+50	Adjusts the amount of blurring between the notes.
Sens (Sensitivity)	
0-100	This controls the input sensitivity of the defretter.
Attack	
0-100	Adjusts the attack of the picking sound.
Depth	
0-100	This controls the rate of the harmonics.
Resonance	
0-100	Adds a characteristically resonant quality to the sound.
EffectLev (Effect Level)	
0-100	Adjust the volume of the defretter sound.
DirectLev (Direct Level)	
0-100	Adjust the volume of the direct sound.

WAVE SYNTH

This is a synth sound that processes the guitar input signal.

Parameter/Range	Explanation
Wave	
Selects a wave type which the synth sound is based.	
Saw	Creates a synth sound with a saw waveform ().
Square	Creates a synth sound with the square waveform ().
Cutoff (Cutoff Frequency)	
0-100	Adjusts the frequency where the harmonics contents of the sound are cut off.
Resonance	
0-100	This adjusts the amount of resonance (and the tone coloration) in the synth sound. The higher the value, the more the synth tone coloration is emphasized.
FLT.Sens (Filter Sensitivity)	
0-100	This adjusts the amount of filtering applied in response to the input.
FLT.Decay (Filter Decay)	
0-100	This sets the time needed for the filter to finish its sweep.
FLT.Depth (Filter Depth)	
0-100	Adjusts the depth of the filter. When the value is higher, the filter will change more drastically.
Synth Lev (Synth Level)	
0-100	Adjusts the volume of the synth sound.
DirectLev (Direct Level)	
0-100	Adjusts the volume of the direct sound.



GUITAR SYNTH

This detects the pitch of an electric guitar and outputs a synthesizer sound.

MEMO

When you use a guitar synthesizer, observe the following points.

- It does not work properly when a chord is played. Be sure to mute all the other strings and play only one note at a time.
- When you are to play the next string while a certain sound is still playing, mute the previous sound and then play the next one with a clear attack.
- If the unit cannot detect the attack, it may not sound correctly.

Parameter/Range	Explanation
Wave	
This selects a wave type that is the source of the guitar synthesizer.	
Square	The unit detects the pitch and attack information from the input guitar sound, then send the square waveform () from the internal sound generator.
Saw	The unit detects the pitch and attack information from the input guitar sound, then send the saw waveform () from the internal sound generator.
Brass	The unit directly processes the input guitar sound and creates a guitar synthesizer sound. It gives a quick sound rise and send the sound with a sharp edge.
Bow	The unit directly processes the input guitar sound and creates a guitar synthesizer sound. It outputs a soft sound without attack.
Sens (Sensitivity)	
0-100	Adjusts the input sensitivity. TIP The response of the internal sound source is better with a higher sensitivity value, but the malfunctions will be increased on the other hand. So, try to set it as high as possible without causing malfunction.
Chromatic *1	
Off, On	This switches on or off the chromatic function. When it is on, the pitch change of the synthesizer sound is in semitone steps. This does not respond to pitch changes less than a semitone, such as what might be obtained with bending or vibrato. Thus, this is effectively used for realistically playing musical instruments whose pitch will change in steps greater than a semitone, such as a keyboard.
Oct Shift *1	
0, -1, -2	This allows you to shift the pitch of the internal sound module in an octave step from the guitar sound.
PWM Rate (Pulse Width Modulation Rate) *2	
0-100	This gives breadth or fatness to the sound by applying modulation to the waveform (only to Square) in the internal sound module. A higher value will quicken the rate of the modulation.

Chapter 8 Parameters Guide

Parameter/Range	Explanation
PWM Depth (Pulse Width Modulation Depth) *2	
0-100	Adjusts the depth of the PWM. When it is set to "0," no PWM effect is obtained.
Cutoff (Cutoff Frequency)	
0-100	Adjusts the frequency where the harmonics contents of the sound are cut off.
Resonance	
0-100	Adjusts how much of the harmonics contents around the cutoff frequency should be emphasized.
FLT.Sens (Filter Sensitivity)	
0-100	Adjusts the sensitivity of the filter. When it is set to a lower value, the filter is affected only with stronger picking. When it is set higher, the filter changes even with weaker picking. When it is set to "0," the depth of the filter will be the same no matter how the picking strength may be.
FLT.Decay (Filter Decay)	
0-100	This sets the time needed for the filter to finish its sweep.
FLT.Depth (Filter Depth)	
-100+100	Adjusts the depth of the filter. When the value is higher, the filter will change more drastically. The polarity of the filter will be opposite with "+" and "-."
Attack	
Decay, 0-100	Adjusts the time needed for a synthesizer sound to reach its maximum. When it is set to a lower value, the sound will rise quickly. When it is set higher, the sound will rise slowly. When it is set to "Decay," the sound will rise quickly and turn to a Release status regardless of the input of the guitar sound. MEMO When "Brass" or "Bow" is selected for the wave, the attack time will not be quicker from a certain level even if the attack is set to "Decay" or "0."
Release	
0-100	This determines the time needed for the synthesizer sound to reach zero from the moment the input of the guitar sound is completed. MEMO When "Brass" or "Bow" is selected for the wave, the guitar signal itself is processed. That is, the synthesizer sound will go down when the guitar signal goes down no matter how long the release may be set.
Velocity	
0-100	This adjusts the amount of the volume change of the synthesizer sound. When it is set to high, the volume change will be greater depending on the picking strength. When it is set to "0," no volume change is caused even by changing the picking manner.

Parameter/Range	Explanation
Hold *1	
Off, On	The hold function can sustain the output of the synthesizer sound. If you turn on the hold while a synthesizer sound is being output, the synthesizer sound will be held until you turn it off. MEMO It is assumed that this parameter will be assigned (p. 126) to the footswitch.
Synth Lev (Synth Level)	
0-100	Adjusts the volume of the synthesizer sound.
DirectLev (Direct Level)	
0-100	Adjusts the volume of the direct sound.

*1 Parameter setting included when Wave is set to "Square" or "Saw."

*2 Parameter setting included when Wave is set to "Square."

SITAR SIM. (Sitar Simulator)

This simulates the sound of the sitar.

Parameter/Range	Explanation
Tone	
-50+50	This adjusts the tone. The high end is boosted as the value increases.
Sens (Sensitivity)	
0-100	Adjusts the sensitivity of the sitar. When it is set to a lower value, no effect of the sitar is obtained with weaker picking, while stronger picking produces the effect. When it is set to a higher value, the effect of the sitar can be obtained whether the picking is weak or strong.
Depth	
0-100	This adjusts the amount of effect applied.
Resonance	
0-100	This adjusts the undulation of the resonance.
Buzz	
0-100	Adjusts the amount of characteristic buzz produced by the "buzz bridge" when the strings make contact with it.
EffectLev (Effect Level)	
0-100	Adjust the volume of the sitar sound.
DirectLev (Direct Level)	
0-100	Adjust the volume of the direct sound.

OCTAVE

This adds a note one octave lower, creating a richer sound.

MEMO

Because of the need to analyze the pitch, chords (two or more sounds played simultaneously) cannot be played.

Parameter/Range	Explanation
Range	
This selects the register to which the effect is applied.	
Range 1	B1 (corresponds to the sound of an open 7th string) to E6 (corresponds to the 1st string played at the 24th fret)
Range 2	B1 (corresponds to the sound of an open 7th string) to E5 (corresponds to the 1st string played at the 12th fret)
Range 3	B1 (corresponds to the sound of an open 7th string) to E4 (corresponds to the sound of an open 1st string)
Range 4	B1 (corresponds to the sound of an open 7th string) to E3 (corresponds to the 4th string played at the 2nd fret)
Oct.Level (Octave Level)	
0-100	Adjusts the volume of the sound one octave below.
DirectLev (Direct Level)	
0-100	Adjusts the volume of the direct sound.

PITCH SHIFTER

This effect changes the pitch of the original sound (up or down) within a range of two octaves.

Parameter/Range	Explanation
Voice	
Selects the number of voices for the pitch shift sound.	
1-Voice	One-voice pitch-shifted sound output in monaural.
2-Mono	Two-voice pitch-shifted sound (PS1, PS2) output in monaural.
2-Stereo	Two-voice pitch-shifted sound (PS1, PS2) output through left and right channels.
PS1/PS2 (Pitch Shift)	
Mode *1	
Selection for the pitch shifter mode.	
Fast, Medium, Slow	The response is slower in the order of FAST, MEDIUM and SLOW, but the modulation is lessened in the same order.
Mono	<p>MEMO</p> <p>You may be unable to produce the intended effect when playing chords (two or more notes played simultaneously).</p>
Pitch *1	
-24-+24	Adjusts the amount of pitch shift (the amount of interval) in semitone steps.
Fine *1	
-50-+50	Make fine adjustments to the interval. The amount of the change in the Fine 100 is equivalent to that of the Pitch 1.
PreDly (Pre Delay) *1	
0 ms-300 ms, BPM ♪ -BPM ♪	Adjusts the time from when the direct sound is heard until the pitch shifted sounds are inputted. Normally you can leave this set at 0ms.
When set to BPM, the value of each parameter will be set according to the value of the "Master BPM" (p. 122) specified for each patch. This makes it easier to achieve effect sound settings that match the tempo of the song.	
* If, due to the tempo, the time is longer than the range of allowable settings, it is then synchronized to a period either 1/2 or 1/4 of that time.	
Fbk (Feedback)	
0-100	Adjusts the feedback amount of the pitch shift sound.
Level *1	
0-100	Adjusts the volume of the pitch shifter
DirectLev (Direct Level)	
0-100	Adjusts the volume of the direct sound.

*1 With Voice set to 2-Mono or 2-Stereo, you can select two sounds.

Chapter 8 Parameters Guide



HARMONIST

Harmonist is an effect where the amount of shifting is adjusted according to an analysis of the guitar input, allowing you to create harmonics based on diatonic scales.

MEMO

- Because of the need to analyze the pitch, chords (two or more sounds played simultaneously) cannot be played.
- You cannot use the Harmonist effect with audio input via USB.

Parameter/Range	Explanation
Voice	
Selects the number of voices for the pitch shift sound.	
1-Voice	One-voice pitch-shifted sound output in monaural.
2-Mono	Two-voice pitch-shifted sound (HR1, HR2) output in monaural.
2-Stereo	Two-voice pitch-shifted sound (HR1, HR2) output through left and right channels.
HR1/HR2 *1	
Harm (Harmony) *1	
This determines the pitch of the sound added to the input sound, when you are making a harmony.	
-2oct→+2oct, User	It allows you to set it by up to 2 octaves higher or lower than the input sound. When the scale is set to USER, this parameter sets the user scale number to be used.
PreDl (Pre Delay) *1	
0ms–300ms, BPM ♪ –BPM ♫	Adjusts the time from when the direct sound is heard until the harmonist sounds are heard. Normally you can leave this set at 0ms.
When set to BPM, the value of each parameter will be set according to the value of the "Master BPM" (p. 122) specified for each patch. This makes it easier to achieve effect sound settings that match the tempo of the song.	
* If, due to the tempo, the time is longer than the range of allowable settings, it is then synchronized to a period either 1/2 or 1/4 of that time.	
Fbk (Feedback)	
0–100	Adjusts the feedback amount of the harmonist sound.
Level *1	
0–100	Adjusts the volume of the harmony sound.
Master Key	
C (Am)–B (G#m)	This sets the key for the HARMONIST.

Parameter/Range	Explanation
The key setting corresponds to the key of the song (#, b) as follows.	
<p>Major C F B^b E^b A^b D^b</p>  <p>Minor Am Dm Gm Cm Fm B^bm</p> <p>Major G D A E B F[#]</p>  <p>Minor Em Bm F[#]m C[#]m G[#]m D[#]m</p>	
DirectLev (Direct Level)	
0–100	Adjusts the volume of the direct sound.
Parameter Range	
UserScale	
UserScale 1–12 *2	
C	▼C – ▼C – C – ▲C – ▲C
D _b	▼D _b – ▼D _b – D _b – ▲D _b – ▲D _b
D	▼D – ▼D – D – ▲D – ▲D
E _b	▼E _b – ▼E _b – E _b – ▲E _b – ▲E _b
E	▼E – ▼E – E – ▲E – ▲E
F	▼F – ▼F – F – ▲F – ▲F
F _#	▼F _# – ▼F _# – F _# – ▲F _# – ▲F _#
G	▼G – ▼G – G – ▲G – ▲G
A _b	▼A _b – ▼A _b – A _b – ▲A _b – ▲A _b
A	▼A – ▼A – A – ▲A – ▲A
B _b	▼B _b – ▼B _b – B _b – ▲B _b – ▲B _b
B	▼B – ▼B – B – ▲B – ▲B
Specify the note name of the output sound. The minus (-) and plus (+) symbols indicate sounds above or below the set note name. Triangles next to the note names indicate octaves. One downward-pointing triangle indicates a note one octave below the note displayed; two triangles indicates a two-octave drop. One upward-pointing triangle indicates a note one octave above the note displayed; two triangles indicates a two-octave rise.	
Note Detect	
Off, On	When this is set to "On," then after the input sound is recognized, the cursor automatically moves to the right (the next sound). Pressing [CATEGORY/ENTER] switches On and Off the Note Detect function.

*1 HR1 and HR2 are set individually.

*2 Effective with User selected for Harm parameter.

Creating Harmonist Scales (User Scale)

When HARM is set to any value from -2oct to +2oct, and the harmony does not sound the way you intend, use a User scale. You can set the corresponding pitches to be output for each input pitch.

1. Set HR1 (or HR2) to User in the HARMONIST screen.
2. Select the screen of the HR1 settings (page 2) or the HR2 settings (page 3) with Cursor [▶].

The User scale setting screen appears.

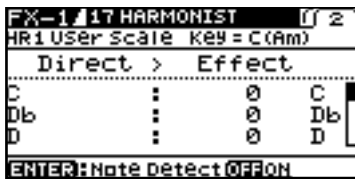

3. Use Cursor [▲] [▼], dial, to set the amount of pitch shift for each voice.

AUTO RIFF

This allows you to automatically produce a phrase simply by picking a single note. This can be used to easily play extremely rapid phrases.

MEMO

- Because of the need to analyze the pitch, chords (two or more sounds played simultaneously) cannot be played.
- Reception of large amounts of MIDI data while Auto Riff is playing may result in disturbances in the sound.

Parameter/Range	Explanation
Phrase	
Preset1–Preset30, User	Select the phrase. User-programmed phrases are used when User is selected.
Loop	
Off, On	If “Loop” is turned “On,” the phrase will be played back continuously.
Tempo	
0–100, BPM ♪ –BPM ♪	Adjusts the speed of the phrase.
When set to BPM, the value of each parameter will be set according to the value of the “Master BPM” (p. 122) specified for each patch. This makes it easier to achieve effect sound settings that match the tempo of the song.	
* If, due to the tempo, the time is longer than the range of allowable settings, it is then synchronized to a period either 1/2 or 1/4 of that time.	
Sens (Sensitivity)	
0–100	Adjust the sensitivity of triggering. With low settings of this parameter, softly picked notes will not retrigger the phrase (i.e., the phrase will continue playing), but strongly picked notes will retrigger the phrase so that it will playback from the beginning. With high settings of this parameter, the phrase will be retriggered even by softly picked notes. No retriggering occurs when the value is set to “0.”
MasterKey *1	
C (Am)–B (G#m)	Select the key of the song that you wish to play.
Attack	
0–100	By adding an attack to each note of the phrase you can produce a sensation as though the notes were being picked.
Hold	
Off, On	If you turn hold “On” after you pick a note, the effect sound will continue even after there is no input signal.
EffectLev (Effect Level)	
0–100	Adjusts the volume of the phrase.
DirectLev (Direct Level)	
0–100	Adjusts the volume of the direct sound.

*1 Setting available with Phrase set to Preset1–30.

Creating Original Phrases (User Phrase)

In addition to the 30 different prepared phrases, you can also create a your own original phrase (User phrases).

1. Set the Phrase parameter to the "User."
2. Select the screen of page 2 with press Cursor [▶].
The USER PHRASE SETTING screen appears.

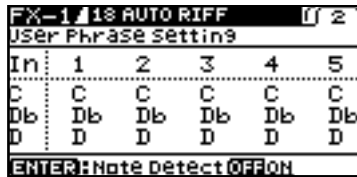

3. Press Cursor [▲][▼][◀][▶] to move the cursor, then rotate the dial to set the User phrase.

In:

This makes the phrase setting with respect to the input sound. For instance, when a C is picked, the phrase shown in the C row is played. Phrases of up to 16 notes can be played.

Parameter	Range
C	▼C - ▼C - C - ▲C - ▲C
D _b	▼D _b - ▼D _b - D _b - ▲D _b - ▲D _b
D	▼D - ▼D - D - ▲D - ▲D
E _b	▼E _b - ▼E _b - E _b - ▲E _b - ▲E _b
E	▼E - ▼E - E - ▲E - ▲E
F	▼F - ▼F - F - ▲F - ▲F
F _‡	▼F _‡ - ▼F _‡ - F _‡ - ▲F _‡ - ▲F _‡
G	▼G - ▼G - G - ▲G - ▲G
A _b	▼A _b - ▼A _b - A _b - ▲A _b - ▲A _b
A	▼A - ▼A - A - ▲A - ▲A
B _b	▼B _b - ▼B _b - B _b - ▲B _b - ▲B _b
B	▼B - ▼B - B - ▲B - ▲B
Specify the note name of the output sound. The minus (-) and plus (+) symbols indicate sounds above or below the set note name. Triangles next to the note names indicate octaves. One downward-pointing triangle indicates a note one octave below the note displayed; two triangles indicates a two-octave drop. One upward-pointing triangle indicates a note one octave above the note displayed; two triangles indicates a two-octave rise.	
---	Indicates a tie. This carries over the same note from the previous step.
End	Determines the last step. The step immediately before the one for which "end" has been set becomes the actual last step.
Note Detect	
Off, On	When this is set to "On," then after the input sound is recognized, the cursor automatically moves to the right (the next sound). Pressing [CATEGORY/ENTER] switches On and Off the Note Detect function.

SOUND HOLD

You can have sound played on the guitar be held continuously. This effect allows you to perform the melody in the upper registers while holding a note in the lower registers.

MEMO

This function will not work properly when two or more notes are played simultaneously.

Parameter/Range	Explanation
Hold	
Off, On	Switches the hold sound on and off. Normally, this is controlled with the CTL 1, 2 pedals or CTL 3/4 jack or the foot-switch connected to the CTL 3,4 jack.
Rise Time	
0-100	Adjusts how rapidly the Sound Hold sound is produced.
EffectLev (Effect Level)	
0-120	Adjusts the volume of the hold sound.

AC.PROCESSOR (Acoustic Processor)

This processor allows you to change the sound produced by the pickup on an acoustic electric guitar, creating a richer sound similar to that obtained with a microphone placed close to the guitar.

Parameter/Range	Explanation
Type	
Selects the modeling type.	
Small	This is the sound of a small-bodied acoustic guitar.
Medium	This is a standard, unadorned acoustic guitar sound.
Bright	This is a bright acoustic guitar sound.
Power	This is a powerful acoustic guitar sound.
Bass	
-50+50	Adjusts the low-end balance.
Middle	
-50+50	Adjusts the midrange balance.
Middle F (Middle Frequency)	
20.0Hz-10.0kHz	Specifies the frequency range to be adjusted with Middle.
Treble	
-50+50	Adjusts the high-end balance.
Presence	
-50+50	Adjusts the balance in the extended upper range.
Level	
0-100	Adjusts the volume.

FEEDBACKER

This allows you to use feedback playing techniques.

MEMO

- Note that the notes you want to apply feedback to must be played singly and cleanly.
- You can use the footswitch to switch the effect on and off. For more details, refer to “Switching Effects On and Off with the Pedals” (p. 55).

Parameter/Range	Explanation
Mode	
OSC	An artificial feedback sound will be created internally. When OSC is selected, the effect is activated after a single note is played and the note stabilizes. A feedback effect is created when the effect switches on; the feedback disappears when the OSC effect switches off.
Natural	Analyzes the pitch of the guitar sound being input, and then creates a feedback sound.
Rise Time *1	
0-100	This determines the time needed for the volume of the feedback sound to reach its maximum from the moment the effect is turned on.
Rise T (▲) (Rise Time (▲))*1	
0-100	This determines the time needed for the volume of the one octave higher feedback sound to reach its maximum from the moment the effect is turned on.
F.B.Level (Feedback Level)	
0-100	Adjusts the volume of the feedback sound.
F.B.Lv (▲) (Feedback Level (▲)) *1	
0-100	Adjusts the volume of the one octave higher feedback sound.
Vib.Rate (Vibrato Rate) *1	
0-100, BPM ♪ -BPM ♪	Adjusts the rate of the vibrato when the feedbacker is on.
When set to BPM, the value of each parameter will be set according to the value of the “Master BPM” (p. 122) specified for each patch. This makes it easier to achieve effect sound settings that match the tempo of the song.	
* If, due to the tempo, the time is longer than the range of allowable settings, it is then synchronized to a period either 1/2 or 1/4 of that time.	
Vib.Depth (Vibrato Depth) *1	
0-100	Adjusts the depth of the vibrato when the feedbacker is on.

*1 Setting available with Mode set to OSC.

ANTI-FEEDBACK



This prevents the acoustic feedback that can be produced by the body resonances of a guitar.

Parameter/Range	Explanation
Freq (Frequency) 1-3	
0-100	Set the fixed frequency point at which feedback will be cancelled. You can set up three cancellation points.
Depth 1-3	
0-100	Adjusts the degree of the anti-feedback at each of the three cancellation points.

Chapter 8 Parameters Guide

PHASER

By adding varied-phase portions to the direct sound, the phaser effect gives a whooshing, swirling character to the sound.

Parameter/Range	Explanation
Type	
Selects the number of stages that the phaser effect will use.	
4 Stage	This is a four-phase effect. A light phaser effect is obtained.
8 Stage	This is an eight-phase effect. It is a popular phaser effect.
12 Stage	This is a twelve-phase effect. A deep phase effect is obtained.
Bi-Phase	This is the phaser with two phase shift circuits connected in series.
Rate	
0–100, BPM ∞ –BPM 	This sets the rate of the phaser effect.
When set to BPM, the value of each parameter will be set according to the value of the “Master BPM” (p. 122) specified for each patch. This makes it easier to achieve effect sound settings that match the tempo of the song.	
* If, due to the tempo, the time is longer than the range of allowable settings, it is then synchronized to a period either 1/2 or 1/4 of that time.	
Depth	
0–100	Determines the depth of the phaser effect.
Manual	
0–100	Adjusts the center frequency of the phaser effect.
Resonance	
0–100	Determines the amount of resonance (feedback). Increasing the value will emphasize the effect, creating a more unusual sound.
Step Rate	
Off, 0–100, BPM ∞ –BPM 	This sets the cycle of the step function that changes the rate and depth. When it is set to a higher value, the change will be finer. Set this to “Off” when not using the Step function.
When set to BPM, the value of each parameter will be set according to the value of the “Master BPM” (p. 122) specified for each patch. This makes it easier to achieve effect sound settings that match the tempo of the song.	
* If, due to the tempo, the time is longer than the range of allowable settings, it is then synchronized to a period either 1/2 or 1/4 of that time.	
EffectLev (Effect Level)	
0–100	Adjusts the volume of the phaser.
DirectLev (Direct Level)	
0–100	Adjusts the volume of the direct sound.

FLANGER

The flanging effect gives a twisting, jet-airplane-like character to the sound.

Parameter/Range	Explanation
Rate	
0–100, BPM ∞ –BPM 	This sets the rate of the flanging effect.
When set to BPM, the value of each parameter will be set according to the value of the “Master BPM” (p. 122) specified for each patch. This makes it easier to achieve effect sound settings that match the tempo of the song.	
* If, due to the tempo, the time is longer than the range of allowable settings, it is then synchronized to a period either 1/2 or 1/4 of that time.	
Depth	
0–100	Determines the depth of the flanging effect.
Manual	
0–100	Adjusts the center frequency at which to apply the effect.
Resonance	
0–100	Determines the amount of resonance (feedback). Increasing the value will emphasize the effect, creating a more unusual sound.
Separation (Separation)	
0–100	Adjusts the diffusion. The diffusion increases as the value increases.
Low Cut (Low Cut Filter)	
Flat, 55Hz–800Hz	This sets the frequency at which the low cut filter begins to take effect. When “Flat” is selected, the low cut filter will have no effect.
EffectLev (Effect Level)	
0–100	Adjusts the volume of the flanger.
DirectLev (Direct Level)	
0–100	Adjusts the volume of the direct sound.

TREMOLO

Tremolo is an effect that creates a cyclic change in volume.

Parameter/Range	Explanation
WaveShape	
0–100	Adjusts changes in volume level. A higher value will steepen wave's shape.
Rate	
0–100, BPM ∞ -BPM ♪	Adjusts the frequency (speed) of the change.
When set to BPM, the value of each parameter will be set according to the value of the "Master BPM" (p. 122) specified for each patch. This makes it easier to achieve effect sound settings that match the tempo of the song.	
* If, due to the tempo, the time is longer than the range of allowable settings, it is then synchronized to a period either 1/2 or 1/4 of that time.	
Depth	
0–100	Adjusts the depth of the effect.

ROTARY

This produces an effect like the sound of a rotary speaker.

Parameter/Range	Explanation
Speed Sel (Speed Select)	
Slow, Fast	This parameter changes the simulated speaker's rotating speed (Slow or Fast).
Rate-Slow	
0–100, BPM ∞ -BPM ♪	This parameter adjusts the Speed Sel of rotation when set to "Slow."
Rate-Fast	
0–100, BPM ∞ -BPM ♪	This parameter adjusts the Speed Sel of rotation when set to "Fast."
When the Rate-Slow or Rate-Fast set to BPM, the value of each parameter will be set according to the value of the "Master BPM" (p. 122) specified for each patch. This makes it easier to achieve effect sound settings that match the tempo of the song.	
* If, due to the tempo, the time is longer than the range of allowable settings, it is then synchronized to a period either 1/2 or 1/4 of that time.	
Rise Time	
0–100	This parameter adjusts the time it takes for the rotation Speed Sel to change when switched from "Slow" to "Fast."
Fall Time	
0–100	This parameter adjusts the time it takes for the rotation Speed Sel to change when switched from "Fast" to "Slow."
Depth	
0–100	This parameter adjusts the amount of depth in the rotary effect.

UNI-V

This models a Uni-Vibe.

Although this resembles a phaser effect, it also provides a unique undulation that you can't get with a regular phaser.

Parameter/Range	Explanation
Rate	
0–100, BPM ∞ -BPM ♪	Adjusts the rate of the Uni-V effect.
When set to BPM, the value of each parameter will be set according to the value of the "Master BPM" (p. 122) specified for each patch. This makes it easier to achieve effect sound settings that match the tempo of the song.	
* If, due to the tempo, the time is longer than the range of allowable settings, it is then synchronized to a period either 1/2 or 1/4 of that time.	
Depth	
0–100	Adjusts the depth of the Uni-V effect.
Level	
0–100	Adjusts the volume.

PAN

With the volume level of the left and right sides alternately changing, when playing sound in stereo, you can get an effect that makes the guitar sound appear to fly back and forth between the speakers.

Parameter/Range	Explanation
Type	
Auto	This varies the volume level on the left and right according to the settings for Wave-Shape, Rate, and Depth.
Manual	Output uses the volume balance set with Position.
WaveShape *1	
0–100	Adjusts changes in volume level. A higher value will steepen wave's shape.
Rate *1	
0–100, BPM ∞ -BPM ♪	Adjusts the frequency (speed) of the change.
When set to BPM, the value of each parameter will be set according to the value of the "Master BPM" (p. 122) specified for each patch. This makes it easier to achieve effect sound settings that match the tempo of the song.	
* If, due to the tempo, the time is longer than the range of allowable settings, it is then synchronized to a period either 1/2 or 1/4 of that time.	
Depth *1	
0–100	Adjusts the depth of the effect.
Position *2	
L100–CENTER–R100	This adjusts the volume balance between the left and right channels.

*1 Setting available when Type is set to Auto.

*2 Setting available when Type is set to Manual.

SLICER

This consecutively interrupts the sound to create the impression that a rhythm backing phrase is being played.

Parameter/ Range	Explanation
Pattern	
P1-P20	Select the slice pattern that will be used to cut the sound.
Rate	
0-100, BPM ∞ -BPM ♪	Adjust the rate at which the sound will be cut.
When set to BPM, the value of each parameter will be set according to the value of the "Master BPM" (p. 122) specified for each patch. This makes it easier to achieve effect sound settings that match the tempo of the song.	
* If, due to the tempo, the time is longer than the range of allowable settings, it is then synchronized to a period either 1/2 or 1/4 of that time.	
Trig Sens (Trigger Sensitivity)	
0-100	Adjust the sensitivity of triggering. With low settings of this parameter, softly picked notes will not retrigger the phrase (i.e., the phrase will continue playing), but strongly picked notes will retrigger the phrase so that it will playback from the beginning. With high settings of this parameter, the phrase will be retriggered even by softly picked notes.

VIBRATO

This effect creates vibrato by slightly modulating the pitch.

Parameter/ Range	Explanation
Rate	
0-100, BPM ∞ -BPM ♪	Adjusts the rate of the vibrato.
When set to BPM, the value of each parameter will be set according to the value of the "Master BPM" (p. 122) specified for each patch. This makes it easier to achieve effect sound settings that match the tempo of the song.	
* If, due to the tempo, the time is longer than the range of allowable settings, it is then synchronized to a period either 1/2 or 1/4 of that time.	
Depth	
0-100	Adjusts the depth of the vibrato.
Trigger	
Off, On	This selects on/off of the vibrato. MEMO It is assumed that this parameter will be assigned (p. 50) to the footswitch.
Rise Time	
0-100	This sets the time passing from the moment the Trigger is turned on until the set vibrato is obtained. MEMO When a patch with Trigger set to On is called up, the effect obtained is identical to what happens when Trigger is switched from Off to On. If you want the vibrato effect to be produced immediately after the patches are switched, set Rise Time to 0.



RING MOD. (Ring Modulator)

This creates a bell-like sound by ring-modulating the guitar sound with the signal from the internal oscillator. The sound can be unmusical and lack distinctive pitches.

Parameter/Range	Explanation
Mode	
This selects the mode for the ring modulator.	
Normal	This is a normal ring modulator.
Intelligent	By ring-modulating the input signal, a bell like sound is created. The intelligent ring modulator changes the oscillation frequency according to the pitch of the input sound and therefore produces a sound with the sense of pitch, which is quite different from Normal. This effect does not give a satisfactory result if the pitch of the guitar sound is not correctly detected. So, you must use single notes, not chords.
Frequency	
0-100	Adjusts the frequency of the internal oscillator.
EffectLev (Effect Level)	
0-100	Adjusts the volume of the effect sound.
DirectLev (Direct Level)	
0-100	Adjusts the volume of the direct sound.

HUMANIZER

This can create human vowel-like sounds.

Parameter/Range	Explanation
Mode	
This sets the mode that switches the vowels.	
Picking	It changes from vowel 1 to vowel 2 along with the picking. The time spent for the change is adjusted with the rate.
Auto	By adjusting the rate and depth, two vowels (Vowel 1 and Vowel 2) can be switched automatically.
Random	Five vowels (A, E, I, O, U) are called out at random by adjusting the rate and depth.
Vowel 1 *1	
a, e, i, o, u	Selects the first vowel.
Vowel 2 *1	
a, e, i, o, u	Selects the second vowel.
Sens (Sensitivity) *2	
0-100	Adjusts the sensitivity of the humanizer. When it is set to a lower value, no effect of the humanizer is obtained with weaker picking, while stronger picking produces the effect. When it is set to a higher value, the effect of the humanizer can be obtained whether the picking is weak or strong.
Rate	
0-100, BPM  -BPM 	Adjusts the cycle for changing the two vowels.
When set to BPM, the value of each parameter will be set according to the value of the "Master BPM" (p. 122) specified for each patch. This makes it easier to achieve effect sound settings that match the tempo of the song.	
* If, due to the tempo, the time is longer than the range of allowable settings, it is then synchronized to a period either 1/2 or 1/4 of that time.	
Depth	
0-100	Adjusts the depth of the effect.
Manual *3	
0-100	This determines the point where the two vowels are switched. When it is set to 50, vowel 1 and vowel 2 are switched in the same length of time. When it is set to lower than 50, the time for vowel 1 is shorter. When it is set to higher than 50, the time for vowel 1 is longer.
Level	
0-100	Adjusts the volume.

*1 Setting available with Mode set to Picking or Auto.

*2 Setting available with Mode set to Picking.

*3 Setting available with Mode set to Auto.

2X2 CHORUS

Frequency band division is employed to produce two different choruses, one for low frequencies and one for higher frequencies, for both the left and right channels (for a total of four). This allows you to achieve a more natural chorus sound.

Parameter/Range	Explanation
Xover f (Crossover Frequency)	
100Hz–4.00kHz	This sets the frequency dividing the low- and high-frequency ranges.
Lo Rate (Low Rate)	
0–100, BPM ◦ –BPM ♪	Adjust the speed of the chorus effect for the low frequency range.
When set to BPM, the value of each parameter will be set according to the value of the “Master BPM” (p. 122) specified for each patch. This makes it easier to achieve effect sound settings that match the tempo of the song.	
* If, due to the tempo, the time is longer than the range of allowable settings, it is then synchronized to a period either 1/2 or 1/4 of that time.	
Lo Depth (Low Depth)	
0–100	Adjust the depth of the chorus effect for the low frequency range. If you wish to use this as a doubling effect, use a setting of 0.
Lo PreDly (Low Pre Delay)	
0.0ms–40.0ms	Adjusts the delay of the effect sound in the low-frequency range. Extending the pre-delay will produce the sensation of multiple sounds (doubling effect).
Lo Level (Low Level)	
0–100	Adjusts the volume of the effect sound in the low-frequency range.
Hi Rate (High Rate)	
0–100, BPM ◦ –BPM ♪	Adjust the speed of the chorus effect for the high frequency range.
When set to BPM, the value of each parameter will be set according to the value of the “Master BPM” (p. 122) specified for each patch. This makes it easier to achieve effect sound settings that match the tempo of the song.	
* If, due to the tempo, the time is longer than the range of allowable settings, it is then synchronized to a period either 1/2 or 1/4 of that time.	
Hi Depth (High Depth)	
0–100	Adjust the depth of the chorus effect for the high frequency range. If you wish to use this as a doubling effect, use a setting of 0.
Hi PreDly (High Pre Delay)	
0.0ms–40.0ms	Adjusts the delay of the effect sound in the high-frequency range. Extending the pre-delay will produce the sensation of multiple sounds (doubling effect).
Hi Level (High Level)	
0–100	Adjusts the volume of the effect sound in the high-frequency range.



SUB DELAY

This is a delay with the maximum delay time of 1,000 ms. This effect is useful for making the sound fatter.

Parameter/Range	Explanation
Dly Time (Delay Time)	
1ms–1000ms, BPM ♪ –BPM ♪	Adjusts the delay time.
When set to BPM, the value of each parameter will be set according to the value of the “Master BPM” (p. 122) specified for each patch. This makes it easier to achieve effect sound settings that match the tempo of the song.	
* If, due to the tempo, the time is longer than the range of allowable settings, it is then synchronized to a period either 1/2 or 1/4 of that time.	
* If you tap [CATEGORY/ENTER], the delay time will change to match the timing of your tapping.	
Feedback	
0–100	Adjusts the volume that is returned to the input. Higher settings will result in more delay repeats.
Hi-Cut (High Cut Filter)	
700Hz–11kHz, Flat	This sets the frequency at which the high cut filter begins to take effect. When “Flat” is selected, the high cut filter will have no effect.
EffectLev (Effect Level)	
0–120	Adjusts the volume of the delay sound.
DirectLev (Direct Level)	
0–100	Adjusts the volume of the direct sound.

DELAY

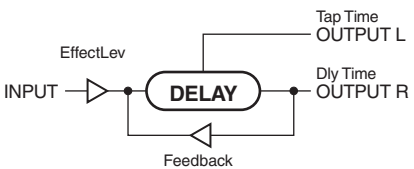
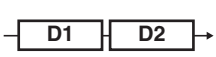
This effect adds delayed sound to the direct sound, giving more body to the sound or creating special effects.

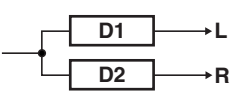
Parameter/Range	Explanation
DELAY ON/OFF	
Off, On	Turns the DELAY Effect on/off. Pressing [DELAY] switches On and Off.
Type	
This selects which type of delay.	
MEMO	
<ul style="list-style-type: none"> If you switch patches with the Type set to either Dual-S, Dual-P, or Dual-L/R and then begin to play immediately after the patches change, you may be unable to attain the intended effect in the first portion of what you perform. The stereo effect is cancelled if a monaural effect or COSM amp is connected after a stereo delay effect.* 	
Single	This is a simple monaural delay.
Pan	This delay is specifically for stereo output. This allows you to obtain the tap delay effect that divides the delay time, then deliver them to L and R channels. 
Stereo	The direct sound is output from the left channel, and the effect sound is output from the right channel.
Dual-S (Dual Series)	This is a delay comprising two different delays connected in series. Each delay time can be set in a range from 1 ms to 1700 ms. 
Dual-P (Dual Parallel)	This is a delay comprising two delays connected in parallel. Each delay time can be set in a range from 1 ms to 1700 ms. 
Dual-L/R	This is a delay with individual settings available for the left and right channels. Delay 1 goes to the left channel, Delay 2 to the right. 
Reverse	This produces an effect where the sound is played back in reverse.
Analog	This gives a mild analog delay sound. The delay time can be set within the range of 1 to 3400 ms
Tape	This setting provides the characteristic wavering sound of the tape echo. The delay time can be set within the range of 1 to 3400 ms.

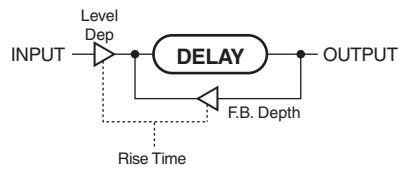
Parameter/Range	Explanation
Warp	This simultaneously controls the delay sound's feedback level and volume to produce a totally unreal delay. 
Modulate	This delay adds a pleasant wavering effect to the sound.

DELAY Common Parameters

Parameter/Range	Explanation
Dly Time (Delay Time)	
1ms–3400ms, BPM ♪ –BPM ♫	This determines the delay time. <p>When set to BPM, the value of each parameter will be set according to the value of the “Master BPM” (p. 122) specified for each patch. This makes it easier to achieve effect sound settings that match the tempo of the song.</p> <p>* If, due to the tempo, the time is longer than the range of allowable settings, it is then synchronized to a period either 1/2 or 1/4 of that time.</p> <p>* If you tap [CATEGORY/ENTER], the delay time will change to match the timing of your tapping.</p>
Feedback	
0–100	This sets the amount of delay sound returned to the input. A higher value will increase the number of the delay repeats. <p>TERM</p> Feedback is returning a delay signal to the input.
High Cut (High Cut Filter)	
700Hz–11kHz, Flat	This sets the frequency at which the high cut filter begins to take effect. When “Flat” is selected, the high cut filter will have no effect.
EffectLev (Effect Level)	
0–120	Adjusts the volume of the delay sound.
DirectLev (Direct Level)	
0–100	Adjusts the volume of the direct sound.

Chapter 8 Parameters Guide

Pan

Parameter/Range	Explanation
Tap Time	
0–100%	Adjusts the delay time of the left channel delay. This setting adjusts the L channel delay time relative to the R channel delay time (considered as 100%).

Dual-S, Dual-P, Dual-L/R

Parameter/Range	Explanation
D1:Time (Delay 1 Time) D2:Time (Delay 2 Time)	
1ms–1700ms, BPM ♪ –BPM ♪	This determines the delay time.
<p>When set to BPM, the value of each parameter will be set according to the value of the “Master BPM” (p. 122) specified for each patch. This makes it easier to achieve effect sound settings that match the tempo of the song.</p> <p>When setting to BPM, press [CATEGORY/ENTER] to display the MASTER BPM screen.</p> <p>If no operation is performed within a set period of time, the display returns to the Delay screen.</p> <p>* If, due to the tempo, the time is longer than the range of allowable settings, it is then synchronized to a period either 1/2 or 1/4 of that time.</p> <p>* After setting D1:Time or D2:Time to a value from 1 ms to 1,700 ms, you can press [CATEGORY/ENTER] to set the value for D1:Time or D2:Time to a value from 1 ms to 1,700 ms according to the interval you press the button.</p> <p>When Type is set to Dual-S or Dual-P, D1:Time is not changed.</p>	
D1:Fbk (Delay 1 Feedback) D2:Fbk (Delay 2 Feedback)	
0–100	Adjusts the amount of feedback of the Delay 1 (or Delay 2). A higher value will increase the number of the delay repeats.
D1:HiCut (Delay 1 High Cut Filter) D2:HiCut (Delay 2 High Cut Filter)	
700Hz–11kHz, Flat	This sets the frequency at which the high cut filter begins to take effect. When “Flat” is selected, the high cut filter will have no effect.
D1:Level (Delay 1 Level) D2:Level (Delay 2 Level)	
0–120	Adjusts the volume of the Delay1 (or Delay 2).

Warp

Parameter/Range	Explanation
Warp Sw	
Off, On	Turns the WARP effect on/off. MEMO This parameter is assigned to the CTL1, CTL2 or CTL 3/4 jack.
Rise Time	
0–100	Adjusts how rapidly the warped delay sound rises.
F.B.Depth (Feedback Depth)	
0–100	Adjusts the feedback level of the warped delay sound.
Level Dep (Level Depth)	
0–100	Adjusts the volume of the warped delay sound.

Modulate

Parameter/Range	Explanation
Mod.Rate (Modulate Rate)	
0–100	Adjusts the modulation rate of the delay sound.
Mod.Depth (Modulate Depth)	
0–100	Adjusts the modulation depth of the delay sound.

CHORUS

In this effect, a slightly detuned sound is added to the original sound to add depth and breadth.

Parameter/Range	Explanation
CHORUS ON/OFF	
Off, On	Turns the CHORUS effect on/off. Pressing [CHORUS] switches On and Off.
Mode	
Selection for the chorus mode.	
Mono	This chorus effect outputs the same sound from both L channel and R channel.
Stereo1	This is a stereo chorus effect that adds different chorus sounds to L channel and R channel.
Stereo2	This stereo chorus uses spatial synthesis, with the direct sound output in the L channel and the effect sound output in the R channel.
Rate	
0–100, BPM –BPM	Adjusts the rate of the chorus effect.
When set to BPM, the value of each parameter will be set according to the value of the “Master BPM” (p. 122) specified for each patch. This makes it easier to achieve effect sound settings that match the tempo of the song.	
* If, due to the tempo, the time is longer than the range of allowable settings, it is then synchronized to a period either 1/2 or 1/4 of that time.	
Depth	
0–100	Adjusts the depth of the chorus effect. To use it for doubling effect, set the value to 0.
Pre Delay	
0.0ms–40.0ms	Adjusts the time needed for the effect sound to be output after the direct sound has been output. By setting a longer pre delay time, you can obtain an effect that sounds like more than one sound is being played at the same time (doubling effect).
Low Cut (Low Cut Filter)	
Flat, 55Hz–800Hz	This sets the frequency at which the low cut filter begins to take effect. When “Flat” is selected, the low cut filter will have no effect.
High Cut (High Cut Filter)	
700Hz–11kHz, Flat	This sets the frequency at which the high cut filter begins to take effect. When “Flat” is selected, the high cut filter will have no effect.
EffectLev (Effect Level)	
0–100	Adjusts the volume of the effect sound.

REVERB

This effect adds reverberation to the sound.

Parameter/Range	Explanation
REVERB ON/OFF	
Off, On	Turns the REVERB effect on/off. Pressing [REVERB] switches On and Off.
Type	
This selects the reverb type. Various different simulations of space are offered.	
Ambience	Simulates an ambience mic (off-mic, placed at a distance from the sound source) used in recording and other applications. Rather than emphasizing the reverberation, this reverb is used to produce a sense of openness and depth.
Room	Simulates the reverberation in a small room. Provides warm reverberations.
Hall 1	Simulates the reverberation in a concert hall. Provides clear and spacious reverberations.
Hall 2	Simulates the reverberation in a concert hall. Provides mild reverberations.
Plate	Simulates plate reverberation (a reverb unit that uses the vibration of a metallic plate). Provides a metallic sound with a distinct upper range.
Spring	This simulates the sound of a guitar amp’s built-in spring reverb.
Modulate	This reverb adds the wavering sound found in hall reverb to provide an extremely pleasant reverb sound.
Rev Time (Reverb Time)	
0.1s–10.0s	Adjusts the length (time) of reverberation.
Pre Delay	
0ms–500ms	Adjusts the time until the reverb sound appears.
Low Cut (Low Cut Filter)	
Flat, 55Hz–800Hz	This sets the frequency at which the low cut filter begins to take effect. When “Flat” is selected, the low cut filter will have no effect.
High Cut (High Cut Filter)	
700Hz–11kHz, Flat	This sets the frequency at which the high cut filter begins to take effect. When “Flat” is selected, the high cut filter will have no effect.
Density	
0–10	Adjusts the density of the reverb sound.
EffectLev (Effect Level)	
0–100	Adjusts the volume of the reverb sound.
DirectLev (Direct Level)	
0–100	Adjusts the volume of the direct sound.
Sprg.Sens (Spring Sensitivity)	
0–100	Adjusts the sensitivity of the spring effect. When the value is set higher, the effect is obtained even with a weak picking.

*1 Setting available with Type set to Spring.



Chapter 8 Parameters Guide

MASTER

These settings are applied to the overall sound.

Parameter/Range	Explanation
Patch Level	
0–200	Adjusts the volume of the patch.
Master Low (Master Low EQ Gain)	
-12→+12dB	Adjusts the low frequency range tone.
Master Mid f (Master Middle EQ Frequency)	
20Hz–10.0kHz	Specify the center of the frequency range that will be adjusted by the “Master Mid G.”
Master Mid Q (Master Middle EQ Q)	
0.5–16	Adjusts the width of the area affected by the EQ centered at the Master Mid f. Higher values will narrow the area.
Master Mid G (Master Middle EQ Gain)	
-12→+12dB	Adjusts the middle frequency range tone.
Master High (Master High EQ Gain)	
-12→+12dB	Adjusts the high frequency range tone.

MASTER BPM/KEY

Parameter/Range	Explanation
Master BPM	
40–250	Adjust the BPM value for each patch.
* BPM (beats per minute) indicates the number of quarter note beats that occur each minute.	
* When you have an external MIDI device connected, the Master BPM synchronizes to the external MIDI device's tempo, making it impossible to set the Master BPM. To enable setting of the Master BPM, set “Sync Clock” (p. 139) to Internal.	
Master Key	
C (Am)–B (G#m)	This sets the key for the FX HARMONIST and the FX AUTO RIFF.
The key setting corresponds to the key of the song (#, b) as follows.	
<p>Major C F B^b E^b A^b D^b</p>  <p>Minor Am Dm Gm Cm Fm B^bm</p> <p>Major G D A E B F[#]</p>  <p>Minor Em Bm F[#]m C[#]m G[#]m D[#]m</p>	

PEDAL FX

SW&PDL FUNCTION

cf.

“Setting CTL/EXP Functions Individually in Each Patch (Pedal FX)” (p. 48)

Parameter/Range	Explanation
CTL1 Func (CTL1 Pedal Function)/ CTL2 Func (CTL2 Pedal Function)/ EXPswFunc (EXP Pedal Switch Function)	
Off	The function is not assign to the pedals.
Ch. A/B	Switches between Preamp channel A and B.
OD Solo	Switches the OD/DS SOLO on and off.
Solo	Switches the Preamp SOLO on and off.
A&B Solo	Switches the preamp SOLO, for both channel A and B, on and off. If one of the two channels is off, both will be turned on.
Comp	Switches the COMP on and off.
OD/DS	Switches the OD/DS on and off.
Preamp	Switches the PREAMP/SPEAKER on and off.
EQ	Switches the EQ on and off.
FX-1	Switches the FX-1 on and off.
FX-2	Switches the FX-2 on and off.
Delay	Switches the DELAY on and off.
Chorus	Switches the CHORUS on and off.
Reverb	Switches the REVERB on and off.
Pedal FX	Switches the Pedal FX on and off.
Send/Return	Switches the SEND/RETURN on and off.
Amp Ctl	Switches the Amp Control on and off.
Tuner	Switches the TUNER/BYPASS on and off.
Manual	Switches the MANUAL MODE on and off.
PL	Switches the PHRASE LOOP on and off.
PL Rec/Play	Records/plays back the phrase.
PL Clear	Clears the phrase.
PL Mute/Ply	Mutes playback of the phrase.
BPM Tap	Used for tap input of the Master BPM.
Delay Tap	Used for tap input of the delay time.
MIDI Start	Controls the Start/Stop of external MIDI devices (such as sequencers).
MMC Play	Controls the Play/Stop of external MIDI devices (such as hard disk recorders).
Lev +10	Increases the patch volume level by 10 units.
Lev +20	Increases the patch volume level by 20 units.
Lev -10	Decreases the patch volume level by 10 units.
Lev -20	Decreases the patch volume level by 20 units.

Parameter/Range	Explanation
Num Inc	Switches to the next higher patch number in the same bank as the currently selected patch.
Num Dec	Switches to the next lower patch number in the same bank as the currently selected patch.
Bank Inc	Switches to the next higher bank number.
Bank Dec	Switches to the next lower bank number.
LED Moment *1	The pedal indicator lights up while you press the pedal, and it goes out when you release the pedal.
LED Toggle *1	The pedal indicator lights up and goes out when alternate each time you press the pedal.
PEDAL FX ON/OFF	
OFF, ON	Switches the status of function assigned to EXP1.
EXP1 Func (EXP Pedal Function)	
Off	The function is not assign to the controller.
Foot Volume	Controls the Foot Volume.
Pedal Bend	Controls the Pedal Bend.
WAH	Controls the WAH.
PB/FV	Controls the Pedal Bend or Foot Volume.
WAH/FV	Controls the WAH or Foot Volume.

*1 This setting value is enabled in CTL1 Func and CTL2 Func.

WAH

You can control the wah effect in real time by adjusting the EXP Pedal or expression pedal connected to the EXP PEDAL 2 jack.



“Setting CTL/EXP Functions Individually in Each Patch (Pedal FX)” (p. 48)

Parameter/Range	Explanation
Type	
This selects the wah type.	
CRY WAH	This models the sound of the CRY BABY wah pedal popular in the '70s.
VO WAH	This models the sound of the VOX V846.
Fat WAH	This a wah sound featuring a bold tone.
Light WAH	This wah has a refined smooth sound.
7String WAH	This expanded wah features a variable range compatible with seven-string and baritone guitars.
Reso WAH	This completely original effect offers enhancements on the characteristic resonances produced by analog synth filters.
Custom	Custom wah You can customize it however you like to match the sound you want.
Pdl Pos. (Pedal Position)	
0–100	Adjusts the position of the wah pedal. MEMO This parameter is used after it's been assigned to an EXP Pedal or similar controller.
Pedal Min (Pedal Minimum)	
0–100	Selects the tone produced when the heel of the EXP Pedal is depressed.
Pedal Max (Pedal Maximum)	
0–100	Selects the tone produced when the toe of the EXP Pedal is depressed.
EffectLev (Effect Level)	
0–100	Adjusts the volume of the wah sound.
DirectLev (Direct Level)	
0–100	Adjusts the volume of the direct sound.

Chapter 8 Parameters Guide

Parameter/Range	Explanation
Custom	
MEMO	
Setting available when Type is set to Custom.	
Type	
This selects the basic sound when the TYPE parameter is set to Custom.	
CRY WAH	This models the sound of the CRY BABY wah pedal popular in the '70s.
VO WAH	This models the sound of the VOX V846.
Fat WAH	This a wah sound featuring a bold tone.
Light WAH	This wah has a refined smooth sound.
7String WAH	This expanded wah features a variable range compatible with seven-string and baritone guitars.
Q	
0-10	Adjusts the amount of characteristic effect applied to the wah tone.
Range Low	
0-10	Selects the tone produced when the pedal is back.
Range High	
0-10	Selects the tone produced when the pedal is forward.
PRESENCE	
0-10	Adjusts the tonal quality of the wah effect.

Pedal Bend/PB

This lets you use the pedal to get a pitch bend effect.

MEMO

Because of the need to analyze the pitch, chords (two or more sounds played simultaneously) cannot be played.

Parameter/Range	Explanation
Pitch Min (Pitch Minimum)	
-24+24	This sets the pitch at the point where the EXP Pedal is fully lifted.
Pitch Max (Pitch Maximum)	
-24+24	This sets the pitch at the point where the EXP Pedal is all the way down.
Pdl Pos. (Pedal Position)	
0-100	Adjusts the pedal position for pedal bend. MEMO This parameter is used after it's been assigned to an EXP Pedal or similar controller.
EffectLev (Effect Level)	
0-100	Adjusts the volume of the pitch bend sound.
DirectLev (Direct Level)	
0-100	Adjusts the volume of the direct sound.

FootVolume/FV

This is a volume control effect.

Normally, this is controlled with the EXP Pedal or the expression pedal connected to the EXP PEDAL 2 jack.

cf.

“Setting CTL/EXP Functions Individually in Each Patch (Pedal FX)” (p. 48)

Parameter/Range	Explanation
Vol. Curve (Volume Curve)	
You can select how the actual volume changes relative to the amount the pedal is pressed.	
Slow 1, Slow 2, Normal, Fast	
Vol. Min (Volume Minimum)	
0-100	Sets the volume when the heel of the EXP Pedal is depressed.
Vol. Max (Volume Maximum)	
0-100	Selects the volume when the toe of the EXP Pedal is depressed.
Level	
0-100	Adjusts the volume.

NOTE

You may be unable to properly obtain the foot volume effect if “FEEDBACKER” (p. 113) is connected at a point after FV in the Effect Chain (p. 38).

Parameters You Can Set with PDL:CTL/EXP

The parameter names displayed in Icon View (or at Play screen 4 (p. 24)) are abbreviated. For information on the parameter names displayed in List View, refer to the chart shown below.



List View	Icon View (at Play screen 4)
Off	Off
Ch. A/B	A/B
OD Solo	ODSolo
Solo	Solo
A&B Solo	ABSolo
Comp	Comp
OD/DS	OD/DS
Preamp	Preamp
EQ	EQ
FX-1	FX-1
FX-2	FX-2
Delay	Delay
Chorus	Chorus
Reverb	Reverb
Pedal FX	PdI FX
Send/Return	S/R
Amp Ctl	AmpCtl
Tuner	Tuner
Manual	Manual
PL	PL
PL Rec/Play	PL R/P
PL Clear	PL Clr
PL Mute/Ply	PL M/P
BPM Tap	BPM Tp
Delay Tap	Dly Tp
MIDI Start	MIDI
MMC Play	MMC
Lev +10	Lev+10
Lev +20	Lev+20
Lev -10	Lev-10
Lev -20	Lev-20
Num Inc	NumInc
Num Dec	NumDec
Bank Inc	BnkInc
Bank Dec	BnkDec
LED Moment	LED Mo
LED Toggle	LED Tg

Chapter 8 Parameters Guide

ASSIGN 1–8

You can freely assign functions to the GT-10's controllers.

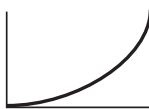
Parameter/Range	Explanation
ASSIGN 1–8 ON/OFF	
Off, On	Turns the ASSIGN1–8 on/off. Pressing [MASTER/PEDAL FX] switches On and Off.
Target	
This selects the parameter to be changed. Refer to "TARGET PARAMETER" (p. 127).	
Min (Minimum)	
This sets the minimum value for the range in which the parameter can change. The value differs depending on the parameter assigned for TARGET PARAMETER.	
Max (Maximum)	
This sets the maximum value for the range in which the parameter can change. The value differs depending on the parameter assigned for TARGET PARAMETER.	
Source	
This selects the controller to which the function is assigned.	
EXP1 PEDAL	EXP Pedal (this unit)
CTL1 PEDAL	CTL 1 pedal (this unit)
CTL2 PEDAL	CTL 2 pedal (this unit)
EXP PEDAL SW	EXP Pedal switch (this unit)
EXP2 PEDAL	Expression pedal connected to the EXP PEDAL 2/SUB CTL 3,4 jack.
CTL3 PEDAL	footswitch connected to the EXP PEDAL 2/SUB CTL 3,4 jack (jack Tip).
CTL4 PEDAL	Expression pedal connected to the EXP PEDAL 2/SUB CTL 3,4 jack (jack Ring).
INTERNAL PDL	Refer to "Activating the Virtual Expression Pedal at the Start of Operations (Internal Pedal System)" (p. 54)
WAVE PEDAL	Refer to "Activating the Virtual Expression Pedal at the Start of Operations (Internal Pedal System)" (p. 54)
INPUT LEVEL	This controls the level of the signal from the INPUT jack. Set the sensitivity in response to the level with Assign INPUT SENS.
CC#1–#31, CC#64–#95	Control Change messages from an external MIDI device (1–31, 64–95)
Src Mode (Source Mode)	
This determines whether the control pedal will function as a momentary type switch (such as the optional FS-5U).	
Moment	The normal state is Off (minimum value), with the switch On (maximum value) only while the footswitch is depressed.
Toggle	The setting is toggled On (maximum value) or Off (minimum value) with each press of the footswitch.

Parameter/Range	Explanation	
ActRngLo (Active Range Low) ActRngHi (Active Range High)		
ActRngLo: 0–126 ActRngHi: 1–127	You can set the controllable range for target parameters within the source's operational range. Target parameters are controlled within the range set with ActRngLo and ActRngHi. You should normally set ActRngLo to 0 and ActRngHi to 127.	
Int Trig (Internal Pedal Trigger)		
This sets the trigger that activates the internal pedal. *1		
Patch Change	This is activated when a patch is selected.	
EXP1 PDL-Low	This is actuated when the EXP Pedal is operated at minimum.	
EXP1 PDL-Mid	This is activated when the EXP Pedal is depressed and an intermediate value is passed.	
EXP1PDL-High	This is actuated when the EXP Pedal is operated at maximum.	
CTL1 PEDAL, CTL2 PEDAL	This is activated when the CTL 1 or 2 pedal on the GT-10 is depressed.	
EXP PEDAL SW	This is activated when the EXP Pedal switch on the GT-10 is turned on.	
EXP2 PEDAL	This is activated when the expression pedal connected to the EXP PEDAL 2/CTL 3,4 jack is depressed.	
CTL3 PEDAL	This is activated when the footswitch (jack Tip) connected to the EXP PEDAL 2/CTL 3,4 jack is depressed.	
CTL4 PEDAL	This is activated when the footswitch (jack Ring) connected to the EXP PEDAL 2/CTL 3,4 jack is depressed.	
CC#1–#31, CC#64–#95	This is activated when the value of the Control Change messages (CC#01–31, 64–95) from an external MIDI device exceeds the middle value.	
Int Time (Internal Pedal Time)		
0–100	This controls the time needed for the assumed EXP Pedal to move from the returned (lifted) position to the depressed (lowered) position. *1	
IntCurve (Internal Pedal Curve)		
This selects one of the three types that determines how the assumed expression pedal changes. *1		
Linear	Slow Rise	Fast Rise
		
WaveRate (Wave Pedal Rate)		
0–100, BPM ∞ –BPM ♪	This determines the time spend for one cycle of the assumed EXP Pedal. *2	
When set to BPM, the value of each parameter will be set according to the value of the "Master BPM" (p. 122) specified for each patch. This makes it easier to achieve effect sound settings that match the tempo of the song.		
* If, due to the tempo, the time is longer than the range of allowable settings, it is then synchronized to a period either 1/2 or 1/4 of that time.		

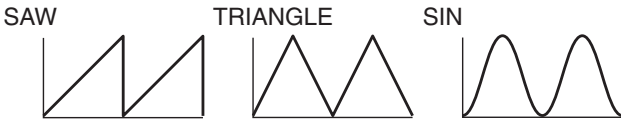
Parameter/Range	Explanation
Waveform (Wave Pedal Form)	
This selects one of the three types that determines how the assumed EXP Pedal should change. *2	
	
INPUT SENS	
0-100	This adjusts the input sensitivity when INPUT LEVEL is selected for Source.

- *1 The Int Trig, Int Time, and IntCurve parameters are enabled when the SOURCE parameter is set to INTERNAL PDL.
- *2 The WaveRate and Waveform parameters are enabled when the Source parameter is set to WAVE PEDAL.

TARGET PARAMETER

COMP (Compressor)

Displayed Parameter	(Real Name)
On/Off	
Type	
Sustain	
Attack	
Threshold	
Release	
Tone	
Level	

OD/DS (Overdrive/Distortion)

Displayed Parameter	(Real Name)
On/Off	
Type	
Drive	
Bottom	
Tone	
Solo Sw	(Solo Switch)
Solo Level	
Effect Level	
Direct Level	

PREAMP

Displayed Parameter	(Real Name)
On/Off	
Ch. Mode	(Channel Mode)
Ch. Select	(Channel Select)
Ch. Dly Time	(Channel Delay Time)
Dynamic Sens	(Dynamic Sensitivity)
A/B: Type	
A/B: Gain	
A/B: Bass	
A/B: Middle	
A/B: Treble	
A/B: Presence	
A/B: Level	
A/B: Bright	
A/B: Gain Sw	(Gain Switch)
A/B: Solo Sw	(Solo Switch)
A/B: Solo Level	
A/B: Speaker Type	
A/B: Mic Type	(Microphone Type)
A/B: Mic Distance	(Microphone Distance)
A/B: Mic Position	(Microphone Position)
A/B: Mic Level	(Microphone Level)
A/B: Direct Level	

Chapter 8 Parameters Guide

EQ (Equalizer)

Displayed Parameter	(Real Name)
On/Off	
Low Cut	
Low Gain	
Low-Mid Freq	(Low-Middle Frequency)
Low-Mid Q	(Low-Middle Q)
Low-Mid Gain	(Low-Middle Gain)
High-Mid Freq	(High-Middle Frequency)
High-Mid Q	(High-Middle)
High-Mid Gain	(High-Middle Gain)
High Gain	
High Cut	
Level	

FX1, FX2: (Effects)

Displayed Parameter	(Real Name)	
On/Off		
Select		
TW: (T.WAH)	Mode	
	Polarity	
	Sens	(Sensitivity)
	Frequency	
	Peak	
	Effect Level	
	Direct Level	
AW: (AUTO WAH)	Mode	
	Frequency	
	Peak	
	Rate	
	Depth	
	Effect Level	
SWH: (SUB WAH)	Type	
	Pdl Position	(Pedal Position)
	Pdl Min	(Pedal Minimum)
	Pdl Max	(Pedal Maximum)
	Effect Level	
	Direct Level	
ACS: (ADV COMP)	Type	
	Sustain	
	Attack	
	Tone	
	Level	
LM: (LIMITER)	Type	
	Attack	
	Threshold	
	Ratio	
	Release	
	Level	

Displayed Parameter	(Real Name)		
GEQ: (GRAPHIC EQ)	31Hz		
	62Hz		
	125Hz		
	250Hz		
	500Hz		
	1kHz		
	2kHz		
	4kHz		
	8kHz		
	16kHz		
	Level		
	PEQ: (PARAMETRIC EQ)	Low Cut	
		Low Gain	
Low-Mid Freq		(Low-Middle Frequency)	
Low-Mid Q		(Low-Middle Q)	
Low-Mid Gain		(Low-Middle Gain)	
Hi-Mid Freq		(High-Middle Frequency)	
Hi-Mid Q		(High-Middle Q)	
Hi-Mid Gain		(High-Middle Gain)	
High Gain			
High Cut			
Level			
TM: (TONE MODIFY)	Type		
	Low		
	High		
	Resonance		
	Level		
GS: (GUITAR SIM)	Type		
	Low		
	High		
	Body		
	Level		
SG: (SLOW GEAR)	Sens	(Sensitivity)	
	RiseTime		
DF: (DEFRETTER)	Tone		
	Sens	(Sensitivity)	
	Attack		
	Depth		
	Resonance		
	Effect Level		
Direct Level			

Displayed Parameter		(Real Name)
WSY: (WAVE SYNTH)	Wave	
	Cutoff	
	Resonance	
	Filter Sens	(Filter Sensitivity)
	Filter Decay	
	Filter Depth	
	Synth Level	
	Direct Level	
GSY: (GUITAR SYNTH)	Sens	(Sensitivity)
	Wave	
	Chromatic	
	Octave Shift	
	PWM Rate	(Pulse Width Modulation Rate)
	PWM Depth	(Pulse Width Modulation Depth)
	Cutoff	
	Resonance	
	Filter Sens	(Filter Sensitivity)
	Filter Decay	
	Filter Depth	
	Attack	
	Release	
	Velocity	
	Hold	
	Synth Level	
Direct Level		
STR: (SITAR SIM)	Tone	
	Sens	(Sensitivity)
	Depth	
	Resonance	
	Buzz	
	Effect Level	
Direct Level		
OC: (OCTAVE)	Range	
	Octave Level	
	Direct Level	
PS: (PITCH SHIFTER)	Voice	
	PS1/2 Mode	
	PS1/2 Pitch	
	PS1/2 Fine	
	PS1/2 Pre Dly	(PS1/2 Pre Delay)
	PS1 Feedback	
	PS1/2 Level	
	Direct Level	
HR: (HARMONIST)	Voice	
	HR1/2 Harmony	
	HR1/2 Pre Dly	(HR1/2 Pre Delay)
	HR1 Feedback	
	HR1/2 Level	
	Direct Level	

Displayed Parameter		(Real Name)
AR: (AUTO RIFF)	Phrase	
	Loop	
	Tempo	
	Sens	(Sensitivity)
	Attack	
	Hold	
	Effect Level	
	Direct Level	
	SH: (SOUND HOLD)	Hold
RiseTime		
Effect Level		
AC: (AC.PROCESSOR)	Type	
	Bass	
	Middle	
	Middle Freq	(Middle Frequency)
	Treble	
	Presence	
	Level	
FB: (FEEDBACKER)	Mode	
	Rise Time	
	Rise T (▲)	(Rise Time (▲))
	F.B. Level	(Feedback Level)
	F.B. Lv (▲)	(Feedback Level (▲))
	Vibrato Rate	
AFB: (ANIT-FEEDBACK)	VibratoDepth	
	Frequency 1	
	Depth 1	
	Frequency 2	
	Depth 2	
	Frequency 3	
PH: (PHASER)	Depth 3	
	Type	
	Rate	
	Depth	
	Manual	
	Resonance	
	StepRate	
	Effect Level	
Direct Level		
FL: (FLANGER)	Rate	
	Depth	
	Manual	
	Resonance	
	Separation	
	Low Cut	
	Effect Level	
Direct Level		

Chapter 8 Parameters Guide

Displayed Parameter		(Real Name)
TR: (TREMLOLO)	Wave Shape	
	Rate	
	Depth	
RT: (ROTARY)	Speed Select	
	Rate Slow	
	Rate Fast	
	Rise Time	
	Fall Time	
	Depth	
UV: (UNI-V)	Rate	
	Depth	
	Level	
PAN:	Type	
	Position	
	Wave Shape	
	Rate	
	Depth	
SL: (SLICER)	Pattern	
	Rate	
	Trigger Sens	(Trigger Sensitivity)
VB: (VIBRATO)	Rate	
	Depth	
	Trigger	
	RiseTime	
RM: (RING MOD.)	Mode	
	Frequency	
	Effect Level	
	Direct Level	
HU: (HUMANIZER)	Mode	
	Vowel 1	
	Vowel 2	
	Sens	(Sensitivity)
	Rate	
	Depth	
	Manual	
	Level	
2CE: (2x2 CHORUS)	Crossover f	(Crossover Frequency)
	Low Rate	
	Low Depth	
	Low Pre Dly	(Low Pre Delay)
	Low Level	
	High Rate	
	High Depth	
	High Pre Dly	(High Pre Delay)
High Level		

Displayed Parameter		(Real Name)
SDD: (SUB DELAY)	Delay Time	
	Feedback	
	High Cut	
	Effect Level	
	Direct Level	

DELAY

Displayed Parameter		(Real Name)
On/Off		
Type		
Delay Time		
Tap Time		
Feedback		
High Cut		
D1/2:	Time	
D1/2:	Feedback	
D1/2:	High Cut	
D1/2:	Level	
Warp Sw		(Warp Switch)
WarpRiseTime		
WarpFB Depth		(Warp Feedback Depth)
WarpLevDepth		(Warp Level Depth)
Modul. Rate		(Modulation Rate)
Modul. Depth		(Modulation Depth)
Effect Level		
Direct Level		

CHORUS

Displayed Parameter		(Real Name)
On/Off		
Mode		
Rate		
Depth		
Pre Delay		
Low Cut		
High Cut		
Effect Level		

REVERB

Displayed Parameter	(Real Name)
On/Off	
Type	
Reverb Time	
Pre Delay	
Low Cut	
High Cut	
Density	
Effect Level	
Direct Level	
Spring Sens	(Spring Sensitivity)

MASTER

Displayed Parameter	(Real Name)
Patch Level	
Master Low	
Master Mid f	(Master Middle Frequency)
Master Mid Q	(Master Middle Q)
Master Mid G	(Master Middle Gain)
Master High	

BPM/KEY

Displayed Parameter	(Real Name)
Master BPM	
Master Key	

AMP CTL (AMP Control)

Displayed Parameter	(Real Name)
Amp Ctl Sw	(Amp Control Switch)

PEDAL

Displayed Parameter	(Real Name)	
On/Off		
WAH	Type	
	PdI Position	(Pedal Position)
	Pedal Min	(Pedal Minimum)
	Pedal Max	(Pedal Maximum)
	Effect Level	
	Direct Level	
PB	Pitch Min	(Pitch Minimum)
	Pitch Max	(Pitch Maximum)
	PdI Position	(Pedal Position)
	Effect Level	
	Direct Level	
FV	Volume Curve	
	Volume Min	(Volume Minimum)
	Volume Max	(Volume Maximum)
	Level	

SEND/RTN (Send/Return)

Displayed Parameter	(Real Name)
On/Off	
Mode	
Send Level	
Return Level	

NS1, NS2 (Noise Suppressor)



Displayed Parameter	(Real Name)
On/Off	
Threshold	
Release	
Detect	

(Others)

Displayed Parameter	(Real Name)	
Tuner Sw	(Tuner Switch)	
Manual ModeSw	(Manual Mode Switch)	
PH LOOP	On/Off	
	Rec/Play	
	Clear	
	Mute/Play	
TAP	BPM Tap	
	Delay Tap	
MIDI	Start/Stop	
	MMCPlay/Stop	
PATCH	Level Inc.10	(Patch Level Increment 10)
	Level Inc.20	(Patch Level Increment 20)
	Level Dec.10	(Patch Level Decrement 10)
	Level Dec.20	(Patch Level Decrement 20)
	Number Inc.	(Patch Number Increment)
	Number Dec.	(Patch Number Decrement)
	Bank Inc.	(Patch Bank Increment)
	Bank Dec.	(Patch Bank Decrement)

SEND/RETURN

This allows you to connect an external effects device to the SEND and RETURN jacks and use it as part of the GT-10's effects.

Parameter/Range	Explanation
SEND/RETURN ON/OFF	
Off, On	Switches the SEND/RETURN on/off. Pressing [MASTER/PEDAL FX] switches On and Off.
Mode	
Switches the SEND/RETURN mode.	
Normal	Outputs the input to SEND/RETURN to the SEND jack and the input from the RETURN jack to the circuit post-SEND/RETURN. Use this when you want to connect an external effects device serially in the GT-10's effects chain. 
Direct Mix	Outputs the input to SEND/RETURN to the SEND jack, mixes the input from the RETURN jack with the input to SEND/RETURN (the direct sound), then outputs this to the circuit post-SEND/RETURN. Use this when you want to mix the GT-10's effects sounds together with the sound with the external effects device applied to it. 
Branch Out	Outputs the input to SEND/RETURN to the SEND jack. The input from the RETURN jack is disregarded. For example, using this with the GT-10's reverb and delay immediately ahead of the SEND/RETURN allows you to use the SEND jack as a direct out. 
Send Lv	
0-200	Adjusts the volume of the output to the external effects device.
Return Lv	
0-200	Adjusts the volume of the input from the external effects device.

AMP CONTROL

By connecting your guitar amp's channel switching jack to the GT-10's AMP CONTROL jack, you can then use Amp Control to switch the amp channel.

This combining of the GT-10 and the amp channels allows you to get an even wider variety of distortion sounds.

Since the Amp Control setting is handled as one of the effects parameters saved to each individual patch, it allows you to switch guitar amp channels with each patch.

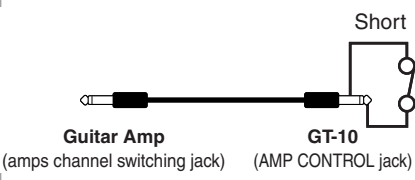
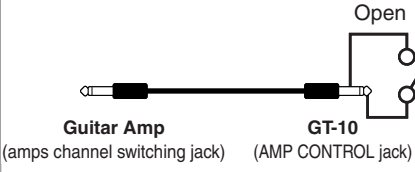
Parameter/Range	Explanation
Amp Control	
Off	
On	

* To determine how the amp channels are switched when the circuit is open and shorted, refer to the amp owner's manual, or actually confirm the sounds by operating the amp.

* Note that, depending on the circuitry of the channel switching jack in the guitar amp used, the Amp Control function may not operate.

MEMO

- With Amp Control, not only can you switch amp channels, you can also use it to switch the amp's effects on and off, like a footswitch controller.
- You can also switch this parameter using [MASTER/PEDAL FX] in the AMP CONTROL screen.

NS1/NS2 (Noise Suppressor)

This effect reduces the noise and hum picked up by guitar pickups. Since it suppresses the noise in synchronization with the envelope of the guitar sound (the way in which the guitar sound decays over time), it has very little effect on the guitar sound, and does not harm the natural character of the sound.

* Please connect the noise suppressor in the signal path prior to the reverb type effect. This setup will prevent a natural break of the reverb type effect.

Parameter/Range	Explanation
NS1, NS2 ON/OFF (Noise Suppressor ON/OFF)	
Off, On	Switches the noise suppressor effect on/off. Pressing [MASTER/PEDAL FX] switches On and Off.
Threshold	
0-100	Adjust this parameter as appropriate for the volume of the noise. If the noise level is high, a higher setting is appropriate. If the noise level is low, a lower setting is appropriate. Adjust this value until the decay of the guitar sound is as natural as possible. * High settings for the threshold parameter may result in there being no sound when you play with your guitar volume turned down.
Release	
0-100	Adjusts the time from when the noise suppressor begins to function until the noise level reaches "0."
Detect	
This controls the noise suppressor based on the volume level for the point specified in Detect.	
Input	Input volume from input jack.
NS Input	Noise suppressor input volume.
FV Out	Volume after passing through Foot Volume.

EZ TONE

This feature allows you to make tone settings based on the equipment you are using and the tonal image you want to create.

STEP 1: SETTING

Parameter/Range	Explanation
YOUR PICKUP	
SINGLE	Single type pickup
HUMBUCKER	Humbucking type pickup
OUTPUT SELECT	
JC-120	Set this when connecting a Roland JC-120 guitar amp.
SMALL AMP	Use this setting when connecting a compact guitar amp.
COMBO AMP	Set this when connecting to the guitar input for a combo-type guitar amp (combining amp and speakers in a single unit) other than a JC-120. * You may find that setting this to JC-120 may produce good results with your guitar amp.
STACK AMP	Use this setting when connecting to the guitar input for a stack-type guitar amp (in which the amp and speakers are separated)
JC-120 Return	Set this when connecting to the JC-120's RETURN.
COMBO Return	Set this when connecting to the RETURN on another combo-type amp.
STACK Return	Set this when connecting to the RETURN on a stack-type amp. Set STACK Return even when using a power amp for the guitar in combination with a speaker cabinet.
LINE/PHONES	Use this setting when using headphones or when recording with the GT-10 connected to a multitrack recorder.

Chapter 8 Parameters Guide

STEP2: TONE

Parameter/Range	Explanation
BASIC TONE	
BASIC TONE lets you create sounds easily by choosing settings close to the musical genre and the feel of the song you want to compose.	
BLUES	Blues sound
Soul Funk	Soul and Funk sound
Jazz	Jazz sound
LIVERPOOL	British Rock
70's HARD ROCK	The Hard Rock sound popular in the '70s.
80s METAL	The Metal sound popular in the '80s
MODERN METAL	Modern Metal sound
West Coast	West Coast sound
FuzzRock	Fuzz
STUDIO	Recording Studio
PROGRESSIVE	Progressive
SURF ROCK	Surf Rock sound
COUNTRY	Country
Acoustic	For Acoustic Guitar
PUNK POP	Punk Pop

STEP3: DRIVE

Parameter/Range	Explanation
SOLO	The distortion to one suitable for solos.
BACKING	The distortion to one suitable for backing.
SOFT	This produces warm distortion.
HARD	This produces sharp distortion.

STEP4: EFX

Parameter/Range	Explanation
WET	This produces a deep effect.
DRY	This produces sound that is close to the original sound.
SHRT (Short)	Echo is shortened.
LONG	Echo is lengthened.

SYSTEM

Used for making settings related to the GT-10's operating environment.

TUNER

Parameter/Range	Explanation
PITCH	
435Hz–445Hz	This sets the reference pitch.
OUTPUT	
Mute	The tuning sound is not output.
Bypass	The tuning sound is output.

INPUT/OUTPUT

Parameter/Range	Explanation
INPUT SELECT	
Guitar 1–Guitar 3, USB In	You can store three separate tone configurations tailored to the guitars you intend to connect (Guitar 1 through 3). Select USB In when you're inputting audio from a computer via USB.
INPUT LEVEL	
-20–+20dB	Input volume from input jack.
PRES. (Presence)	
-20–+20dB	Adjusts the ultra high frequency range tone.
GLOBAL EQ	
Low Gain	
-20–+20dB	Adjusts the low frequency range tone.
Mid Gain (Middle Gain)	
-20–+20dB	Adjusts the middle frequency range tone.
Mid Freq (Middle Frequency)	
20.0Hz–10.0kHz	Specifies the center of the frequency range that will be adjusted by the Mid Gain.
Mid Q (Middle Q)	
0.5–16	Adjusts the width of the area affected by the EQ centered at the Mid Freq. Higher values will narrow the area.
High Gain	
-20–+20dB	Adjusts the high frequency range tone.

Parameter/Range	Explanation
TOTAL	
NS Threshold (Noise Suppressor Threshold)	
-20→+20dB	This controls the global threshold level for the noise suppressor settings in each patch. This feature is effective when you connect a different guitar or for adjusting for changes in noise levels in the performance venue. It does not affect the settings in each individual patch. MEMO To use the settings contained in the individual patches, set this to 0 dB.
Rev Level (Reverb Level)	
0–200%	This controls the global reverb level for the reverb settings in each patch. Adjusting this reverb level is effective for adjusting to the acoustics of the performance space. It does not affect the settings in each individual patch. MEMO To use the settings contained in the individual patches, set this to 100%.
USB/DGT Out Lev (USB/Digital Out Level)	
0–200%	Adjusts the volume level of the digital audio signals output to the USB (Computer).
USB Mix Level	
0–200%	Sets the volume level of the mixed digital audio signals from USB (Computer) when Input Select is set to “Guitar 1–3.”
Main Out Level	
This sets the output reference level to match the equipment connected to the OUTPUT jack.	
-10dB	Choose this when connected to a guitar amp.
+4dB	Choose this when connected to a recorder, mixer, or other line device.

PHRASE LOOP

Parameter/Range	Explanation
PHRASE LOOP	
Off, On	Switches the Phrase Loop function on/off.
Mode	
Performance	This records the sound after it passes through the effects. This lets you achieve a rich variety of performances by combining different tones.
Patch Edit	This records the sound before it passes through the effects, and applies the effects during loop play. This enables you to adjust effects or compare patch tones.
Pdl Mode (Pedal Mode)	
Off	The BANK pedals are not used for operation of the Phrase Loop feature. These are used as bank switch pedals. TIP Phrase Loop can be controlled by assigning the Phrase Loop feature to any of the CTL 1 through 4 etc. and maintaining the BANK pedals' bank switching function.
On	The BANK pedals are used for operation of the Phrase Loop feature.
Rec Mode (Recording Mode)	
Mono	Phrases are recorded in mono.
Stereo	Phrases are recorded in stereo.
Play Lev (Play Level)	
0–120	Sets the phrase playback volume.
Clear Pdl (Clear Pedal Function)	
Clear Only	When you press [BANK ▲] while the Phrase Loop feature is on, the recorded data is cleared and then GT-10 switches to STANDBY mode.
Mute/Clear	When you press [BANK ▲] while the Phrase Loop feature is on, the performance of the recorded phrase is muted (the recorded data is not erased). If you then press [BANK ▲] again while the phrase is muted, the recorded data is cleared and then GT-10 switches to STANDBY mode. TIP Skillful use of muting lets you combine your own performances with prerecorded phrases at the timing you want.

MANUAL MODE SETTING

Parameter/Range	Explanation
Number Pedal 1–4, BANK▼Pedal, BANK▲Pedal	
The Number pedal and the BANK pedal are used for switching specified effects on and off.	
Off	The function is not assign to the pedals.
Ch.A/B	Switches between Preamp channel A and B.
OD Sol	Switches the OD/DS SOLO on and off.
Solo	Switches the Preamp SOLO on and off.
A&BSol	Switches the preamp SOLO, for both channel A and B, on and off. If one of the two channels is off, both will be turned on.
Comp	Switches the COMP on and off.
OD/DS	Switches the OD/DS on and off.
Preamp	Switches the PREAMP/SPEAKER on and off.
EQ	Switches the EQ on and off.
FX1	Switches the FX-1 on and off.
FX2	Switches the FX-2 on and off.
Delay	Switches the DELAY on and off.
Chorus	Switches the CHORUS on and off.
Reverb	Switches the REVERB on and off.
PdIFX	Switches the Pedal FX on and off.
S/R	Switches the SEND/RETURN on and off.
AmpCtl	Switches the Amp Control on and off.
Tuner	Switches the TUNER/BYPASS on and off.
PL	Switches the PHRASE LOOP on and off.
PL R/P	Records/plays back the phrase.
PL Clr	Clears the phrase.
PL M/P	Mutes playback of the phrase.
BPMTap	Used for tap input of the Master BPM.
DlyTap	Used for tap input of the delay time.
MIDI	Controls the Start/Stop of external MIDI devices (such as sequencers).
MMCPly	Controls the Play/Stop of external MIDI devices (such as hard disk recorders).
Lev+10	Increases the patch volume level by 10 units.
Lev+20	Increases the patch volume level by 20 units.
Lev-10	Decreases the patch volume level by 10 units.
Lev-20	Decreases the patch volume level by 20 units.
NumInc	Switches to the next higher patch number in the same bank as the currently selected patch.
NumDec	Switches to the next lower patch number in the same bank as the currently selected patch.
BnkInc	Switches to the next higher bank number.
BnkDec	Switches to the next lower bank number.

PLAY OPTION

Parameter/Range	Explanation
Preamp Mode	
Patch	The patch preamp setting is used. This allows you to use different preamp settings in each individual patch.
System1–3	The system's preamp setting is used. This applies the same preamp settings to all patches.
Patch ChgMode (Patch Change Mode)	
This setting determines whether or not the decay of reverb, delay, and similar effects continue when patches are switched on the GT-10.	
Fast	Patches are changed normally. The unit switches to the subsequent patch without any carry-over of the decay from the previous patch's reverb or delay.
Smooth	The unit switches to the subsequent patch with the decay from the previous patch's reverb or delay continued after the switch is made. MEMO To ensure smooth switching, the patches may be switched with a delay of one tempo beat.
Bank Chg Mode	
This sets the timing with which the GT-10 switches to the next patch when switching banks with the pedals.	
Wait	Although the indication in the display is updated to reflect the change in the bank when a BANK pedal is pressed, the patch will not change until a number pedal has been pressed.
Immed	The patch switches instantly when a BANK pedal or any of the number pedals is pressed.
BankExtentMin (Bank Extent Minimum)	
P01–P50, U01–U50	Sets the lower limit for the banks.
BankExtentMax (Bank Extent Maximum)	
P01–P50, U01–U50	Sets the upper limit for the banks.
EXP Pdl Hold (Expression Pedal Hold)	
This setting determines whether or not the Assign's (p. 50) operational status is carried over to the next patch when patches are switched.	
Off	The Assign's operational status is not carried over. (Example) If a patch is switched while the volume is being controlled with an EXP Pedal, the volume of the subsequent patch is set to the value set in that patch. If the EXP Pedal is operated, the volume will change in accord with the pedal's movement.

Parameter/Range	Explanation
On	The Assign's operational status is carried over. (Example) If a patch is switched while the volume is being controlled with the EXP Pedal, the volume of the subsequent patch will take on the value determined by the current pedal position (angle). If the patch switched to has the EXP Pedal controlling the wah effect, then the volume assumes the value set in the patch, and the patch's wah effect is given the value derived from the current pedal position (angle).
Pdl Indicate (Pedal Indicate)	
You can have all unlit pedal indicators flash faintly instead.	
Off	The Pedal Indicate function is not use.
On	All unlit pedal indicators flash.
Num Pdl Sw (Number Pedal Switch)	
This allows you to call up various features by pressing the pedals with the same numbers as the currently selected patches.	
Off	This function is not operational.
Tuner	Switches the Tuner on and off.
Ch. A/B	Switches between Preamp channel A and B.
OD Solo	Switches the OD/DS SOLO on and off.
Solo	Switches the Preamp SOLO on and off.
AB Solo	Switches the preamp SOLO, for both channel A and B, on and off.
Dial Func (Dial Function)	
This setting determines whether or not rotating the dial switches the patches.	
Pat&Val	The dial is used both for switching patches and changing the value of settings. In addition to switching patches with the pedals, you can also switch them by rotating the dial.
Value	The dial is used only for changing the values of settings.

CONTROLLER

Parameter/Range	Explanation
SYS KNOB SETTING (System Knob Setting)	
Knob P1-P4	COMP:Sustain, COMP:Attack, COMP:Threshld, COMP:Release, COMP:Level, ODDS:Drive, ODDS:Tone ODDS:EffectLev, ODDS:Solo Lev, PRE-A(B):Gain, PRE-A(B):Level PRE-A(B):Bass, PRE-A(B):Mid PRE-A(B):Treble, PRE-A(B):Presnce PRE-A(B):SoloLev, EQ:Low Cut EQ:Low Gain, EQ:Lo-MidGain, EQ:Hi-MidGain, EQ:High Gain EQ:High Cut, DELAY:Time, DELAY:Feedbak, DELAY:Hi Cut DELAY:EfctLev, DELAY:D1(2)Time DELAY:D1(2)Fbk, DELAY:D1(2)HCut DELAY:D1(2)Lev, CHORUS:Rate CHORUS:Depth, CHORUS:PreDly CHORUS:E.Lev, REVERB:Time REVERB:Hi Cut, REVERB:E.Lev MASTER:Low, MASTER:Mid MASTER:High, Patch Level PDL:Wah E.Lev, PDL:PB E.Lev SR:Send Level, SR:Rtn Level NS1(2):Threshold, NS1(2):Release GLOBAL EQ:Low, GLOBAL EQ:Mid GLOBAL EQ:Hi
EXP1/2 PEDAL SETTING	
Prefernc (Preference)	
Patch	The patch pedal setting is used. This allows you to use different pedal settings in each individual patch.
System	The CONTROLLER screen's pedal setting (Function, Min and Max) is used. This applies the same pedal settings to all patches.
Function	
Off	The function is not assign to the controller.
Foot Volume	Controls the Foot Volume.
Pedal Bend *1	Controls the Pedal Bend.
WAH *1	Controls the WAH.
PB/FV *1	Controls the Pedal Bend or Foot Volume.
WAH/FV *1	Controls the WAH or Foot Volume.
Patch Level	Controls the Patch Level.
*1 This parameter is enabled in EXP1 PEDAL SETTING.	
Min (Minimum)	
0-100	This sets the minimum value for the range in which the parameter can change.
Max (Maximum)	
0-100 0-200 (Function = Patch Level)	This sets the maximum value for the range in which the parameter can change.

Chapter 8 Parameters Guide

Parameter/ Range	Explanation
EXP PEDAL SW SETTING (Expression Pedal Switch Setting)	
CTL1-4 PEDAL SETTING (CTL1-4 Pedal Setting)	
Prefernc (Preference)	
Patch	The patch pedal setting is used. This allows you to use different pedal settings in each individual patch.
System	The CONTROLLER screen's pedal setting (Function, Min, Max and Src Mode) is used. This applies the same pedal settings to all patches.
Function	
Off	The function is not assign to the controller.
Ch. A/B	Switches between Preamp channel A and B.
OD Solo Sw	Switches the OD/DS SOLO on and off.
Solo Sw	Switches the Preamp SOLO on and off.
A&B Solo	Switches the preamp SOLO, for both channel A and B, on and off. If one of the two channels is off, both will be turned on.
Comp Sw	Switches the COMP on and off.
OD/DS Sw	Switches the OD/DS on and off.
Preamp Sw	Switches the PREAMP/SPEAKER on and off.
EQ Sw	Switches the EQ on and off.
FX-1 Sw	Switches the FX-1 on and off.
FX-2 Sw	Switches the FX-2 on and off.
Delay Sw	Switches the Delay on and off.
Chorus Sw	Switches the Chorus on and off.
Reverb Sw	Switches the Reverb on and off.
Pedal FX Sw	Switches the Pedal FX on and off.
Send/Rtn Sw	Switches the Send&Return on and off.
Amp Ctl Sw	Switches the Amp Control on and off.
Tuner	Switches the Tuner/Bypass on and off.
Manual Sw	Switches the Manual mode on and off.
PL Sw	Switches the PHRASE LOOP on and off.
PL Rec/Play	The phrase is recorded/played.
PL Clear	The phrase is deleted.
PL Mute/Ply	Phrase loop play is muted.
BPM Tap	Used for tap input of the Master BPM.
Delay Tap	Used for tap input of the delay time.
MIDI Start	Controls the Start/Stop of external MIDI devices (such as sequencers).
MMC Play	Controls the Play/Stop of external MIDI devices (such as hard disk recorders).
P.Lev Inc1	Increases the patch volume level by 10 units.
P.Lev Inc2	Increases the patch volume level by 20 units.
P.Lev Dec1	Decreases the patch volume level by 10 units.
P.Lev Dec2	Decreases the patch volume level by 20 units.

Parameter/ Range	Explanation
P.Num Inc	Switches to the next higher patch number in the same bank as the currently selected patch.
P.Num Dec	Switches to the next lower patch number in the same bank as the currently selected patch.
P.Bank Inc	Switches to the next higher bank number.
P.Bank Dec	Switches to the next lower bank number.
Min (Minimum)	
Off, On	This sets the value for times when the switch is Off.
Max (Maximum)	
Off, On	This sets the value for times when the switch is On.
Src Mode (Source Mode)	
This sets the behavior of the value each time the switch is operation.	
Moment	The normal state is Off (minimum value), with the switch On (maximum value) only while the footswitch is depressed.
Toggle	The setting is toggled On (maximum value) or Off (minimum value) with each press of the footswitch.

Display of Parameters You Can Set with SYS KNOB SETTING

The parameter names displayed in the Play screen are abbreviated. For details about the parameter names, refer to the chart shown below.

Display with SYS KNOB SETTING	Display at Play screen 1	Display at the bottom of the Play screen
COMP:Sustain	COMP SUSTN	CS SUS
COMP:Attack	COMP ATACK	CS ATK
COMP:Threshld	COMP THRES	CS THR
COMP:Release	COMP RELE	CS REL
COMP:Level	COMP LEVEL	CS LEV
ODDS:Drive	ODDS DRIVE	OD DRV
ODDS:Tone	ODDS TONE	OD TNE
ODDS:EfectLev	ODDS E LEV	OD ELV
ODDS:Solo Lev	ODDS S LEV	OD SLV
PRE:A:Gain	PRE-A GAIN	AchGAN
PRE:A:Level	PRE-A LEVEL	AchLEV
PRE:A:Bass	PRE-A BASS	AchBAS
PRE:A:Mid	PRE-A MID	AchMID
PRE:A:Treble	PRE-A TREBL	AchTRB
PRE:A:Presnce	PRE-A PRES	AchPRS
PRE:A:SoloLev	PRE-A S LEV	AchSLV
PRE:A:Mic Lev	PRE-A M LEV	AchMLV
PRE:B:Gain	PRE-B GAIN	BchGAN
PRE:B:Level	PRE-B LEVEL	BchLEV
PRE:B:Bass	PRE-B BASS	BchBAS
PRE:B:Mid	PRE-B MID	BchMID
PRE:B:Treble	PRE-B TREBL	BchTRB

Display with SYS KNOB SETTING	Display at Play screen 1	Display at the bottom of the Play screen
PRE:B:Presnce	PRE-B PRES	BchPRS
PRE:B:SoloLev	PRE-B S LEV	BchSLV
PRE:B:mic Lev	PRE-B M LEV	BchMLV
EQ:Low Cut	EQ L CUT	EQ LC
EQ:Low Gain	EQ LOW	EQ LOW
EQ:Lo-MidGain	EQ L MID	EQ LMD
EQ:Hi-MidGain	EQ H MID	EQ HMD
EQ:High Gain	EQ HIGH	EQ HI
EQ:High Cut	EQ H CUT	EQ HC
DELAY:Time	DELAY TIME	DD TIM
DELAY:Feedbak	DELAY FBK	DD FBK
DELAY:Hi Cut	DELAY H CUT	DD HC
DELAY:EfctLev	DELAY E LEV	DD ELV
DELAY:D1:Time	DELAY D1TIM	D1 TIM
DELAY:D1:Fbk	DELAY D1FBK	D1 FBK
DELAY:D1:HCut	DELAY D1HC	D1 HC
DELAY:D1:Lev	DELAY D1LEV	D1 LEV
DELAY:D2:Time	DELAY D2TIM	D2 TIM
DELAY:D2:Fbk	DELAY D2FBK	D2 FBK
DELAY:D2:HCut	DELAY D2HC	D2 HC
DELAY:D2:Lev	DELAY D2LEV	D2 LEV
CHORUS:Rate	CHORS RATE	CE RAT
CHORUS:Depth	CHORS DEPTH	CE DPT
CHORUS:PreDly	CHORS P DLY	CE DLY
CHORUS:E.Lev	CHORS E LEV	CE LEV
REVERB:Time	REVRB TIME	RV TIM
REVERB:Hi Cut	REVRB H CUT	RV HC
REVERB:E.Lev	REVRB E LEV	RV ELV
MASTER:Low	MST LOW	MT LOW
MASTER:Mid	MST MID	MT MID
MASTER:High	MST HIGH	MT HI
Patch Level	PATCH LEVEL	PAT LV
PDL:WAH:E.Lev	PEDA WAH E	WA ELV
PDL:PB:E.Lev	PEDAL PB E	PB ELV
SR:Send Level	SR S LEV	SR SND
SR:Rtn Level	SR R LEV	SR RTN
NS1:Threshold	NS1 THRES	N1 THR
NS1:Release	NS1 RELE	N1 REL
NS2:Threshold	NS2 THRES	N2 THR
NS2:Release	NS2 RELE	N2 REL
GLOBAL EQ:Low	GBEQ LOW	GB LOW
GLOBAL EQ:Mid	GBEQ MID	GB MID
GLOBAL EQ:Hi	GBEQ HIGH	GB HI

LCD

Parameter/Range	Explanation
Contrast	
1-16	Adjusts the contrast.

MIDI

Parameter/Range	Explanation
Rx Channel (Receive Channel)	
1-16ch	This sets the MIDI channel used for receiving MIDI messages.
Omni Mode	
Omni Off, Omni On	When set to "Omni On," messages are received on all channels, regardless of the MIDI channel settings.
Tx Channel (Transmit Channel)	
1-16ch	This sets the MIDI Transmit channel used for transmitting MIDI messages.
Device ID	
1-32	This sets the Device ID used for transmitting and receiving Exclusive messages.
Sync Clock	
This setting determines the basis used for synchronizing the timing for effect modulation rates and other time-based parameters.	
NOTE	
<ul style="list-style-type: none"> When you have an external MIDI device connected, the Master BPM is then synchronized to the external MIDI device's tempo, thus disabling the Master BPM setting. To enable setting of the Master BPM, set to "Internal." When synchronizing performances to the MIDI Clock signal from an external MIDI device, timing problems in the performance may occur due to errors in the MIDI Clock. 	
Auto	When the MIDI Clock of the external MIDI device is not being received, the performance is synchronized to the tempo set in MASTER BPM; when the external MIDI device's MIDI Clock is being received from the USB or MIDI IN connector, the performance is synchronized to that.
Internal	The performance is synchronized to the tempo set in MASTER BPM.
PC Out (Program Change Out)	
This setting determines whether or not Program Change messages are output when patches are switched on the GT-10.	
Off	Program Change messages are not output, even when patches are switched.
On	Program Change messages are simultaneously output when patches are switched.

Chapter 8 Parameters Guide

Parameter/Range	Explanation
EXP1/EXP Sw/CTL1/CTL2/EXP2/CTL3/CTL4 Out (Transmit Control Change)	
This sets the controller number when the controller operation data is output as Control Change messages.	
Off, CC#1–CC#31, CC#64–CC#95	Selects the controller.
Map Select	
This setting determines whether patches are switched according to the Program Change Map settings, or to the default settings.	
Fix	Switches to the patches according to the default settings.
Prog	Switches to the patches according to the Program Change Map.
PROGRAM MAP	
When switching patches using Program Change messages transmitted by an external MIDI device, you can freely set the correspondence between Program Change messages received by the GT-10 and the patches to be switched to in the “PROGRAM MAP.”	
Bank 0–3 / PC#1–PC#128	This sets the patch number (P01-1 through U50-4) for the corresponding Program Change number.
BULK DUMP	
On the GT-10, you can use Exclusive messages to provide another GT-10 with identical settings, and save effect settings on a MIDI sequencer or other device.	
SYSTEM	System Parameters
Quick	Settings for User Quick Setting
U01-1–U50-4	Settings for Patch Number U01-1 through U50-4
Temp	Settings for the patch that is currently called up

USB

Parameter/Range	Explanation
Driver Mode	
Standard	This mode uses the OS's standard USB driver. MEMO You cannot use MIDI when Standard is selected as the driver mode. If you want to use MIDI with the USB connection, set the GT-10 to the advanced driver mode.
Advanced	This mode uses the special driver.
Monitor Cmd (Monitor Command)	
Disable	The Direct Monitor command is disabled, maintaining the Direct Monitor mode set by the GT-10.
Enable	The Direct Monitor command is enabled, allowing the Direct Monitor mode to be switched from an external device.
Dir.Monitor (Direct Monitor)	
Off	Set this to Off if transmitting audio data internally through a computer (Thru). No sound is heard at this time unless the setting for the computer is Thru.
On	The GT-10 sound is output. Set this to On when using the GT-10 as a standalone device, without connecting to a computer (only USB input sound will be output if this is set to Off).
MEMO	
<ul style="list-style-type: none"> This setting cannot be saved. It is set to On when the power is turned on. If you are using the special driver, you can control Dir.Monitor On/Off from ASIO 2.0-compatible application. 	

OUTPUT SELECT

This selects the type of device to be connected.

Parameter/ Range	Explanation
Mode	
Patch	This uses the patch's Output Select setting. You can use a different output setting for each individual patch.
System	This uses the system's Output Select setting. The same output setting is used for all patches.
Select	
JC-120	Set this when connecting a Roland JC-120 guitar amp.
SMALL AMP	Use this setting when connecting a compact guitar amp.
COMBO AMP	Set this when connecting to the guitar input for a combo-type guitar amp (combining amp and speakers in a single unit) other than a JC-120. * <i>You may find that setting this to JC-120 may produce good results with your guitar amp.</i>
STACK AMP	Use this setting when connecting to the guitar input for a stack-type guitar amp (in which the amp and speakers are separated)
JC-120 Return	Set this when connecting to the JC-120's RETURN.
COMBO Return	Set this when connecting to the RETURN on another combo-type amp.
STACK Return	Set this when connecting to the RETURN on a stack-type amp. Set STACK Return even when using a power amp for the guitar in combination with a speaker cabinet.
LINE/PHONES	Use this setting when using headphones or when recording with the GT-10 connected to a multitrack recorder. * <i>Use the LINE/PHONES setting if you are using a speaker simulator.</i> MEMO When headphones are connected to the PHONES jack, tonal adjustments are applied so the sound is close to that produced by the guitar amp.

Appendices

Signal Flow

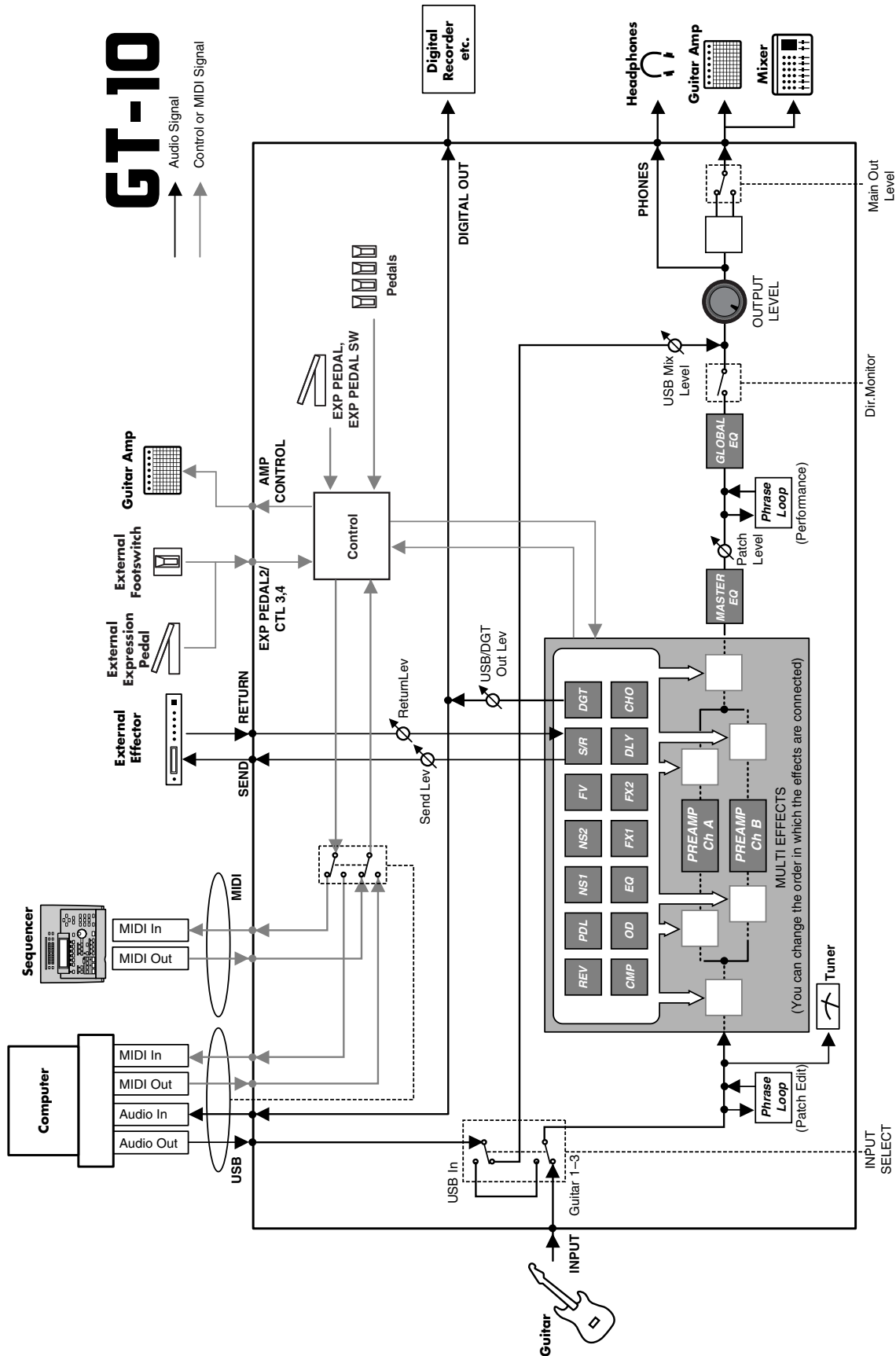

MIDI Implementation Chart

GUITAR EFFECTS PROCESSOR

Date: Jan. 10, 2008

Model GT-10

MIDI Implementation Chart

Version: 1.00

Function...	Transmitted	Recognized	Remarks
Basic Channel Default Changed	1-16 1-16	1-16 1-16	Memorized
Mode Default Messages Altered	X X *****	OMNI ON/OFF X X	Memorized
Note Number : True Voice	X *****	X *****	
Velocity Note ON Note OFF	X X	X X	
After Touch Key's Ch's	X X	X X	
Pitch Bend	X	X	
Control Change 0, 32 1-31 33-63 64-95	O (0-3) O X O	O * 1 O * 2 X O * 2	Bank Select
Prog Change : True #	O 0-99	O 0-127	Program Number 1-128
System Exclusive	O	O	
System Common : Song Pos : Song Sel : Tune	X X X	X X X	
System Real Time : Clock : Command	X O	O X	
Aux Message : All sound off : Local ON/OFF : All Notes OFF : Active Sense : Reset	X X X O X	X X X O X	
Notes	* 1 CC#0 data of a value of 04H or higher, and the CC#32 are ignored. * 2 Recognizes messages designated for use for "realtime control over parameters."		

Mode 1 : OMNI ON, POLY

Mode 2 : OMNI ON, MONO

O : Yes

Mode 3 : OMNI OFF, POLY

Mode 4 : OMNI OFF, MONO

X : No

Specifications

GT-10: Guitar Effects Processor

AD Conversion

24-bit + AF method

DA Conversion

24-bit

Sampling Frequency

44.1 kHz

Program Memories

400: 200(user) + 200(preset)

Nominal Input Level

INPUT: -10 dBu

RETURN: -10 dBu

Input Impedance

INPUT: 1 M ohm

RETURN: 220 k ohms

Nominal Output Level

OUTPUT: -10 dBu / +4 dBu

SEND: -10 dBu

Output Impedance

OUTPUT: 2 k ohms

SEND: 3 k ohms

Dynamic Range

100 dB or greater (IHF-A)

Digital Output

Coaxial type (conforms to IEC60958)

Display

132 x 64 dots graphic LCD (backlit LCD)

7 segments, 3 characters LED

Connectors

INPUT jack (1/4 inch phone type)

OUTPUT jacks L/MONO, R (1/4 inch phone type)

PHONES jack (Stereo 1/4 inch phone type)

EXT LOOP jacks SEND, RETURN (1/4 inch phone type)

AMP CONTROL jack (1/4 inch phone type)

EXP PEDAL 2/CTL3,4 jack (1/4 inch TRS phone type)

USB connector

DIGITAL OUT jack (coaxial type)

MIDI connectors IN, OUT

DC IN jack

Power Supply

DC 9 V (AC Adaptor: Roland PSB-1U)

Current Draw

800 mA

Dimensions

542 (W) x 272 (D) x 77 (H) mm

21-3/8 (W) x 10-3/4 (D) x 3-1/16 (H) inches

Maximum height:

542 (W) x 272 (D) x 104 (H) mm

21-3/8 (W) x 10-3/4 (D) x 4-1/8 (H) inches

Weight

4.9 kg / 10 lbs 13 oz (excluding AC Adaptor)

Accessories

AC Adaptor (Roland PSB-1U)

Owner's Manual

Roland Service (Information Sheet)

Options

Footswitch: BOSS FS-5U

Dual Footswitch: BOSS FS-6

Expression Pedal: BOSS FV-500L/500H, Roland EV-5

Footswitch Cable: Roland PCS-31

(1/4 inch Phone plug (stereo) - 1/4 inch Phone plug (mono) x2)

* 0 dBu = 0.775 Vrms

NOTE

In the interest of product improvement, the specifications and/or appearance of this unit are subject to change without prior notice.

AF method (Adaptive Focus method)

This is a proprietary method from Roland & BOSS that vastly improves the signal-to-noise (S/N) ratio of the A/D and D/A converters.

Error Messages

If there has been a mistake in an operation or if the operation is not executed properly, an error message will appear in the display.

Please follow the instructions indicated in the message to resolve the issue.

“MIDI BUFFER FULL”

“USB BUFFER FULL”

- The data cannot be processed correctly due to the high volume of MIDI messages.
- Reduce the volume of MIDI messages transmitted to the GT-10.

“MIDI OFFLINE”

“USB OFFLINE”

- Transmissions from the connected device have been interrupted. This message also appears when the power to the connected device has been turned off. It does not indicate damage.
- Check to make sure no cable is disconnected and that there are no shorts.

“DATA WRITE ERROR”

- Writing to the memory for storage of user data failed.
- The unit may be damaged. Consult the nearest Roland service center.

Troubleshooting

If there is no sound or other operational problems occur, first check through the following solutions. If this does not resolve the problem, then contact your dealer or a nearby Roland service station.

Problems with the sound

No sound / volume too low

- Are the connection cables broken?**
 - Try using a different set of connection cables.
 - Is the GT-10 correctly connected to the other devices?**
 - Check connections with the other devices (p. 22).
 - Is the connected amp/mixer turned off, or the volume lowered?**
 - Check the settings of your amp/mixer system.
 - Is the OUTPUT LEVEL knobs lowered?**
 - Adjust the OUTPUT LEVEL knobs to an appropriate position (p. 24).
 - Is Tuner set to On?**
 - When the volume is set to “Mute” in the Tuner mode, even the direct sound will not be output by setting the Tuner to “On” (p. 28).
 - Is each effect set correctly?**
 - Use the “Changing the Connection Order of Effects (Effect Chain)” (p. 38) to check the output level of each effect. If there is an effect for which the meter does not move, check the settings for that effect.
 - Is “USB/DGT Out Lev” set to a low value?**
 - Adjust the setting to an appropriate value (p. 135).
 - Is “PEDAL: FV: Level” or “MASTER: Patch Level” specified as an assign Target?**
 - Move the controller to which it is assigned.
 - Is the power to the external device connected to the EXT LOOP jack off, or is the volume of the device turned down?**
 - Check the settings for the connected device.
- #### Sound from devices connected to the INPUT jack is not heard in the headphones
- Is the Dir.Monitor (p. 93) set to OFF?**
 - Set to ON.

The volume level of the instrument connected to INPUT and RETURN are too low

- ❑ Could you be using a connection cable that contains a resistor?
- Use a connection cable that does not contain a resistor.

Oscillating sound occurs

- ❑ Is the value for any gain- or volume-related effects parameter set too high?
- Lower these values.
- ❑ Is the INPUT SELECT (p. 61) set to "USB In"?
- When set to "USB In," audio signals may, depending on the software settings, end up looping. You can use the following methods to prevent this from happening.
 - Stop playback with the software, and set Soft Thru to Off.
 - Switch the software's audio input off.
 - Change INPUT SELECT to "Guitar 1-3."

No change in preamp tone even after switching patches

- Has the GT-10 been set to "System1-3" in Preamp mode (p. 69)?
- When the GT-10 is set to "System1-3" in Preamp mode, the preamp settings do not change when patches are switched.
To make different preamp settings for individual patches, choose the "Patch" setting in Preamp mode.

Unable to change parameters with the knobs or dial

- Are you using the Internal Pedal System (p. 54) in Assign?
- When the Assign Source is set to "INTERNAL PDL" or "WAVE PDL," the effect parameter set as the Assign Target changes automatically.
If you want to be able to change the parameters manually with the knobs and dial, first switch off Assign to deactivate the Internal Pedal System.
- Is "INPUT LEVEL" (p. 50) set as the Assign Source in Assign?
- When "INPUT LEVEL" is set for the Assign Source, the effect parameter set as the Assign Target changes automatically according to the level of the input from the guitar (the playing dynamics).
If you want to be able to change the parameters manually with the knobs and dial, first switch off Assign.

Other Problems

Patch does not change

- ❑ Is something other than the Play screen shown in the display?
- On the GT-10, patches can be selected only when the Play screen is displayed. Press [EXIT] to return to the Play screen (p. 24).

Parameters specified with Assign can't be controlled

- ❑ Could the effect be switched off?
- To control a parameter using the EXP Pedal or footswitch, make sure the effect that contains the parameter you intend to control is switched on.
- ❑ Is Preference ("preference") for Pedal Function set to the "System" setting?
- Even when an assignment setting has been made for the patch, the setting made for Pedal Function (p. 47) takes precedence. To enable the setting made for the patch, for Pedal Function set the preference for the relevant controller to Patch.
- ❑ Do the MIDI channel settings of both devices match?
- Make sure that the MIDI channels of both devices match (p. 80).
- ❑ Do the controller number settings of both devices match?
- Make sure that the controller number of both devices match (p. 126).

MIDI messages are not transmitted/received

- ❑ Are the MIDI cables broken?
- Try another set of MIDI cables.
- ❑ Is the GT-10 correctly connected to the other MIDI device?
- Check connections with the other MIDI device.
- ❑ Do the MIDI channel settings of both devices match?
- Make sure that the MIDI channels of both devices match (p. 80).
- ❑ When you send messages from the GT-10, make sure the GT-10 is set to the settings appropriate for sending data.
- Check the on/off status for transmission of program change messages (p. 84) and the settings for the controller numbers to be transmitted (p. 84).

Index

Numerics

- 2X2 CHORUS 102
- 2x2 CHORUS 118

A

- AC Adaptor 22
- AC.PROCESSOR 102, 112
- Acoustic Processor 102, 112
- ADV.COMP 102, 104
- Advanced Compressor 102, 104
- Amp 22–23
- AMP CONTROL 22, 132
- AMP CONTROL Jack 13
- ANTI- FEEDBACK 102
- Anti Feedback 102
- ANTI-FEEDBACK 113
- Assign 50
- ASSIGN 1–8 126
- AUTO RIFF 102, 111
- Auto Riff 102
- AUTO WAH 102–103
- Auto Wah 102

B

- Bank 16
- Bank Change Mode 72
- Bank Extent 71
- BANK Pedals 12
- BOTTOM 97
- Bulk Dump 87
- Bulk Load 89

C

- CATEGORY 31, 39
- CATEGORY NAME 40
- CATEGORY/ENTER Button 12
- CHORUS 121
- CHORUS Button 11
- COMP 96
- COMP Button 11
- Compressor 96
- Connection 14, 22
- Contrast 67
- Control Change 79, 85
- CONTROLLER 137
- Controller 53
- Copy 42
- CREATE Button 11
- CTL Pedal 79
- CTL Pedals 12

D

- DC IN Jack 13
- DEFRETTER 102, 106
- Defretter 102
- DELAY 119
- DELAY Button 11
- Dial 11

- Dial Function 75
- DIGITAL OUT 66
- DIGITAL OUT Connector 13
- Direct Monitor 93
- DISPLAY MODE Button 11
- Driver Mode 91
- Dual-L/R 120
- Dual-P 120
- Dual-S 120

E

- EDIT Button 11
- Effect
 - Level 38
 - On and Off 34
- Effect Chain 38
- EFFECTS SELECT 11
- EQ 101
- EQ Button 11
- Equalizer 101
- EXIT Button 11
- EXP Pedal 12, 79
 - Adjusting 77
- EXP Pedal Hold 73
- EXP PEDAL SW 12, 79
- EXP PEDAL/CTL 3, 4 Jack 13
- Expression Pedal 22
- expression pedal 22
- EXT LOOP Jacks 13
- External Effects 23, 26
- EZ TONE 11, 32, 133
 - CREATE 32
 - EDIT 33
- EZ Tone 20

F

- Factory Reset 76
- Factory Settings 76
- FEEDBACKER 102, 113
- Feedbacker 102
- FLANGER 102, 114
- Flanger 102
- Foot Switch 22
- FootVolume 125
- FX-1 102
- FX-1 Button 11
- FX-2 102
- FX-2 Button 11

G

- Global 62
- Global EQ 62
- GRAPHIC EQ 102, 104
- Graphic Equalizer 102, 104
- Guitar Amp 26
- GUITAR SIM. 102, 106
- Guitar Simulator 102, 106
- GUITAR SYNTH 102, 107

Guitar Synth	102	OD/DS Button	11
H		OUTPUT Jacks	13
HARMONIST	102, 110	OUTPUT L/MONO	22
Harmonist	102	OUTPUT LEVEL	24
Harmonist Scale	111	OUTPUT LEVEL Knob	11
HIGH	97	OUTPUT SELECT	141
HUMANIZER	102, 117	Output Select	25
Humanizer	102	OUTPUT SELECT Button	11
I		Overdrive/Distortion	96
Initialize	43	P	
INPUT Jack	13	PAN	102, 115
Input Level	61	Pan	102, 120
Input Presence	61	PARA EQ	102, 105
Input Select	61	Parameter	36
INPUT/OUTPUT	134	Parameter Knobs	11
Internal Pedal	54, 126	Parametric Equalizer	102, 105
Internal Pedal System	54	PATCH	
K		COPY	42
KEY	122	EXCHANGE	43
Knob View	35	INITIALIZE	43
L		SELECT	16
LCD Contrast	67, 139	WRITE	42
Level Meter	38	Patch	16, 29
LIMITER	102, 104	Patch Change Mode	68
Limiter	102	PATCH NAME	41
LINE/PHONES	25	PEAK	103
List View	35	Pedal	47
LOW	97	Pedal Bend	124
M		Pedal Function	47
Main Out Level	65	PEDAL FX	122
Manual Mode	55	Pedal FX	48
MANUAL MODE SETTING	136	Pedal Indicate	74
Manual Settings	51	PHASER	102, 114
MASTER	122	Phaser	102
MASTER BPM	122	PHONES Jack	13
MASTER/PEDAL FX Button	11	Phrase	
MIDI	79, 139	Deleting	59
MIDI IN/OUT Connectors	13	Overdubbing	58
MIDI Map Select	84	Recording	58
MIDI Sequencer	89	PHRASE LOOP	12, 135
MODE switch	22	Phrase Loop	58
Modulate	120	PITCH SHIFTER	102, 109
N		Pitch Shifter	102
NAME		PLAY OPTION	136
CATEGORY	40	Play Screen	23
PATCH	41	POLARITY switch	22
Noise Suppressor	133	POWER Switch	13
NS	133	PREAMP	98
NS1	133	PREAMP Button	11
NS2	133	Preamp Mode	69
Number	16	Preset Bank	29
Number Pedal	16, 57	Program Change	79
Number Pedals	12	Program Change Map	84
O		Q	
OCTAVE	102, 109	Quick Setting	35
Octave	102	R	
OD/DS	96	RETURN	132
		REVERB	121
		REVERB Button	11
		RING MOD.	102, 117

Ring Modulator	102, 117
RISE TIME	120
ROTARY	102, 115
Rotary	102

S

Saving a Patch	42
SELECT Button	11
SEND	132
SEND/RETURN	132
SEND/RETURN Jacks	15
Sitar	108
SITAR SIM.	102, 108
Sitar Simulator	102, 108
SLICER	102, 116
Slicer	102
SLOW GEAR	102, 106
Slow Gear	102
SOUND HOLD	102, 112
Sound Hold	102
Speaker	22
Speaker Simulator	25
SUB DELAY	102, 118
Sub Delay	102
SUB WAH	102–103
Sub Wah	102
SW&PDL FUNCTION	122
Swap	43
SYSTEM	134
SYSTEM Button	11

T

T.WAH	102
Target	53
TARGET PARAMETER	127
TONE MODIFY	102, 105
Tone Modify	102
TOP	97
Total Noise Suppressor	63
Total REVERB	64
Touch Wah	102
TREMOLO	102, 115
Tremolo	102
TUNER	26, 134
Tuner	26
TUNER/BYPASS Button	12
TYPE	98, 119

U

UNI-V	102, 115
USB	90
USB Connector	13
USB Driver	90
User Bank	29
User Patch	29, 43
User Phrase	112
User Quick Setting	44
User Scale	111

V

VIBRATO	102, 116
Vibrato	102
View	
Knob	35

List	35
Volume	22
Volume-swell Effect	106

W

WAH	123
Warp	120
Wave Pedal	54, 126
WAVE SYNTH	102
Wave Synth	102
WAVE SYNTH.	107
Write	42
WRITE Button	12



MEMO







有关产品中所含有害物质的说明

本资料就本公司产品中所含的特定有害物质及其安全性予以说明。

本资料适用于 2007 年 3 月 1 日以后本公司所制造的产品。

环保使用期限



此标志适用于在中国国内销售的电子信息产品，表示环保使用期限的年数。所谓环保使用期限是指在自制造日起的规定的期限内，产品中所含的有害物质不致引起环境污染，不会对人身、财产造成严重的不良影响。

环保使用期限仅在遵照产品使用说明书，正确使用产品的条件下才有效。不当的使用，将会导致有害物质泄漏的危险。

产品中有毒有害物质或元素的名称及含量

部件名称	有毒有害物质或元素					
	铅(Pb)	汞(Hg)	镉(Cd)	六价铬(Cr(VI))	多溴联苯(PBB)	多溴二苯醚(PBDE)
外壳(壳体)	×	○	○	○	○	○
电子部件(印刷电路板等)	×	○	×	○	○	○
附件(电源线、交流适配器等)	×	○	○	○	○	○

○：表示该有毒有害物质在该部件所有均质材料中的含量均在 SJ/T11363-2006 标准规定的限量要求以下。
 ×：表示该有毒有害物质至少在该部件的某一均质材料中的含量超出 SJ/T11363-2006 标准规定的限量要求。
 因根据现有的技术水平，还没有什么物质能够代替它。

For EU Countries



- UK** This symbol indicates that in EU countries, this product must be collected separately from household waste, as defined in each region. Products bearing this symbol must not be discarded together with household waste.
- DE** Dieses Symbol bedeutet, dass dieses Produkt in EU-Ländern getrennt vom Hausmüll gesammelt werden muss gemäß den regionalen Bestimmungen. Mit diesem Symbol gekennzeichnete Produkte dürfen nicht zusammen mit dem Hausmüll entsorgt werden.
- FR** Ce symbole indique que dans les pays de l'Union européenne, ce produit doit être collecté séparément des ordures ménagères selon les directives en vigueur dans chacun de ces pays. Les produits portant ce symbole ne doivent pas être mis au rebut avec les ordures ménagères.
- IT** Questo simbolo indica che nei paesi della Comunità europea questo prodotto deve essere smaltito separatamente dai normali rifiuti domestici, secondo la legislazione in vigore in ciascun paese. I prodotti che riportano questo simbolo non devono essere smaltiti insieme ai rifiuti domestici. Ai sensi dell'art. 13 del D.Lgs. 25 luglio 2005 n. 151.
- ES** Este símbolo indica que en los países de la Unión Europea este producto debe recogerse aparte de los residuos domésticos, tal como esté regulado en cada zona. Los productos con este símbolo no se deben depositar con los residuos domésticos.
- PT** Este símbolo indica que nos países da UE, a recolha deste produto deverá ser feita separadamente do lixo doméstico, de acordo com os regulamentos de cada região. Os produtos que apresentem este símbolo não deverão ser eliminados juntamente com o lixo doméstico.
- NL** Dit symbool geeft aan dat in landen van de EU dit product gescheiden van huishoudelijk afval moet worden aangeboden, zoals bepaald per gemeente of regio. Producten die van dit symbool zijn voorzien, mogen niet samen met huishoudelijk afval worden verwijderd.
- DK** Dette symbol angiver, at i EU-lande skal dette produkt opsamles adskilt fra husholdningsaffald, som defineret i hver enkelt region. Produkter med dette symbol må ikke smides ud sammen med husholdningsaffald.
- NO** Dette symbolet indikerer at produktet må behandles som spesialavfall i EU-land, iht. til retningslinjer for den enkelte regionen, og ikke kastes sammen med vanlig husholdningsavfall. Produkter som er merket med dette symbolet, må ikke kastes sammen med vanlig husholdningsavfall.
- SE** Symbolen anger att i EU-länder måste den här produkten kasseras separat från hushållsavfall, i enlighet med varje regions bestämmelser. Produkter med den här symbolen får inte kasseras tillsammans med hushållsavfall.
- FI** Tämä merkintä ilmaisee, että tuote on EU-maissa kerättävä erillään kotitalousjätteistä kunkin alueen voimassa olevien määräysten mukaisesti. Tällä merkinnällä varustettuja tuotteita ei saa hävittää kotitalousjätteiden mukana.
- HU** Ez a szimbólum azt jelenti, hogy az Európai Unióban ezt a terméket a háztartási hulladéktól elkülönítve, az adott régióban érvényes szabályozás szerint kell gyűjteni. Az ezzel a szimbólummal ellátott termékeket nem szabad a háztartási hulladék közé dobni.
- PL** Symbol oznacza, że zgodnie z regulacjami w odpowiednim regionie, w krajach UE produktu nie należy wyrzucać z odpadami domowymi. Produktów opatrzonych tym symbolem nie można utylizować razem z odpadami domowymi.
- CZ** Tento symbol udává, že v zemích EU musí být tento výrobek sbírán odděleně od domácího odpadu, jak je určeno pro každý region. Výrobky nesoucí tento symbol se nesmí vyhazovat spolu s domácím odpadem.
- SK** Tento symbol vyjadruje, že v krajinách EÚ sa musí zber tohto produktu vykonávať oddelene od domového odpadu, podľa nariadení platných v konkrétnej krajine. Produkty s týmto symbolom sa nesmú vyhazovať spolu s domovým odpadom.
- EE** See sümbol näitab, et EL-i maades tuleb see toode olemprügist eraldi koguda, nii nagu on igas piirkonnas määratletud. Selle sümboliga märgitud tooteid ei tohi ära visata koos olmeprügiga.
- LT** Šis simbolis rodo, kad ES šalyse šis produktas turi būti surenkamas atskirai nuo buitinių atliekų, kaip nustatyta kiekviename regione. Šiuo simboliu paženklinėti produktai neturi būti išmetami kartu su buitinių atliekomis.
- LV** Šis simbols norāda, ka ES valstīs šo produktu jāievāc atsevišķi no mājsaimniecības atkritumiem, kā noteikts katrā reģionā. Produktus ar šo simbolu nedrīkst izmest kopā ar mājsaimniecības atkritumiem.
- SI** Ta simbol označuje, da je treba proizvod v državah EU zbirati ločeno od gospodinjjskih odpadkov, tako kot je določeno v vsaki regiji. Proizvoda s tem znakom ni dovoljeno odlagati skupaj z gospodinjjskimi odpadki.
- GR** Το σύμβολο αυτό υποδηλώνει ότι στις χώρες της Ε.Ε. το συγκεκριμένο προϊόν πρέπει να συλλέγεται χωριστά από τα υπόλοιπα οικιακά απορρίμματα, σύμφωνα με όσα προβλέπονται σε κάθε περιοχή. Τα προϊόντα που φέρουν το συγκεκριμένο σύμβολο δεν πρέπει να απορρίπτονται μαζί με τα οικιακά απορρίμματα.

- * Microsoft and Windows are registered trademarks of Microsoft Corporation.
- * Windows® is known officially as: “Microsoft® Windows® operating system.”
- * Apple and Macintosh are registered trademarks of Apple Inc.
- * Mac OS is a trademark of Apple Inc.
- * All product names mentioned in this document are trademarks or registered trademarks of their respective owners.

For the U.K.

IMPORTANT: THE WIRES IN THIS MAINS LEAD ARE COLOURED IN ACCORDANCE WITH THE FOLLOWING CODE.

BLUE: NEUTRAL
BROWN: LIVE

As the colours of the wires in the mains lead of this apparatus may not correspond with the coloured markings identifying the terminals in your plug, proceed as follows:

The wire which is coloured BLUE must be connected to the terminal which is marked with the letter N or coloured BLACK.
The wire which is coloured BROWN must be connected to the terminal which is marked with the letter L or coloured RED.
Under no circumstances must either of the above wires be connected to the earth terminal of a three pin plug.

For EU Countries



This product complies with the requirements of EMC Directive 2004/108/EC.

For the USA

FEDERAL COMMUNICATIONS COMMISSION RADIO FREQUENCY INTERFERENCE STATEMENT

This equipment has been tested and found to comply with the limits for a Class B digital device, pursuant to Part 15 of the FCC Rules. These limits are designed to provide reasonable protection against harmful interference in a residential installation. This equipment generates, uses, and can radiate radio frequency energy and, if not installed and used in accordance with the instructions, may cause harmful interference to radio communications. However, there is no guarantee that interference will not occur in a particular installation. If this equipment does cause harmful interference to radio or television reception, which can be determined by turning the equipment off and on, the user is encouraged to try to correct the interference by one or more of the following measures:

- Reorient or relocate the receiving antenna.
- Increase the separation between the equipment and receiver.
- Connect the equipment into an outlet on a circuit different from that to which the receiver is connected.
- Consult the dealer or an experienced radio/TV technician for help.

This device complies with Part 15 of the FCC Rules. Operation is subject to the following two conditions:

- (1) this device may not cause harmful interference, and
- (2) this device must accept any interference received, including interference that may cause undesired operation.

Unauthorized changes or modification to this system can void the users authority to operate this equipment.
This equipment requires shielded interface cables in order to meet FCC class B Limit.

For Canada

NOTICE

This Class B digital apparatus meets all requirements of the Canadian Interference-Causing Equipment Regulations.

AVIS

Cet appareil numérique de la classe B respecte toutes les exigences du Règlement sur le matériel brouilleur du Canada.

For the USA

DECLARATION OF CONFORMITY Compliance Information Statement

Model Name : GT-10
Type of Equipment : Guitar Effects Processor
Responsible Party : Roland Corporation U.S.
Address : 5100 S.Eastern Avenue, Los Angeles, CA 90040-2938
Telephone : (323) 890-3700

